

TRANSOCEANIC DISPERSAL STUDIES OF INSECTS

By E. P. Holzapfel and J. C. Harrell

BISHOP MUSEUM, HONOLULU, HAWAII

Abstract: A brief review of literature on insect dispersal with mention of the modes of transport across oceans, aerial densities, effects of weather, and early observations and collections from aircraft and ships at sea serves to introduce the ship trapping program started by Bishop Museum in 1957 as a phase of its studies of the zoogeography and evolution of insects in the Pacific. A resumé of the collecting equipment and a summary of the insects reported from 1957 through 1966 is presented. Three separate collections from the Yellow Sea were selected in an attempt to postulate several possible trajectories from the point of collection at sea to the probable point of origin on land. Mention is made of the shift from a qualitative to a quantitative approach to the problem.

Dispersal, a vital aspect of zoogeography, is of prime importance for the species if it is to succeed. Increase of the mean distance between neighboring individuals (Schneider 1962) is a phenomenon common to all organisms. One of the earliest records of the mass migration of animals appears in the book of Exodus, written in about 1500 B.C. This first record of dispersal deals with winged insects and it can be pointed out that the problem of mass migration of locusts remains an unsolved problem.

Man has long observed the meanderings of various animals. It was speculated late in the 19th Century that insects were capable of being transported by some unknown means across vast expanses of open seas. Earlier, most workers felt that land organisms would be completely blocked by an ocean. Observations of the fairly regular migrations of locusts in Africa and their periodic appearance in southern and central Europe, and records of sightings from ships in the English Channel and in the Mediterranean helped in removing the concept that oceans served as impassable obstacles to dispersal. Even so, Guppy as late as 1925 voiced a difficulty in accepting a 3200 km air trip from California to Hawaii.

C. B. Williams (1930, 1942, 1943, 1958) and Walker (1931) have presented relatively complete reviews of the literature concerning the dispersal of insects during the past 1000 years over both land and sea, and Poulton (1923, 1931) and Dannreuther (1933) published further records.

Locusts and Lepidoptera were the first insects to be recorded as moving over expanses of water; even today, the record of small insects over oceans is rather poorly documented though over land it has been found that the "aerial plankton" is essentially made up of insects of small size which are usually weak flyers with a large surface-weight ratio (Hardy & Milne 1938). Recent publications have shown that strong fliers such as dragonflies along with weak fliers such as Coleoptera and smaller insects such as aphids are present in the air in small numbers a considerable distance from land.

Although a number of records documenting the movement of insects over the ocean had been published in the late 19th and early 20th Century, there was often speculation as to where these insects had originated or where they were destined. The first proof of insects being transported over a considerable distance was the publication by C. S. Elton in 1925 resulting from an expedition to Spitsbergen in August 1924 during which large black aphids were observed in numbers over a broad area. (About 80% of these were alive, resting on snow surface, although their wings were almost dry.) A smaller number of yellow and black hover flies were also seen and collected alive, as well as one large tipulid fly. After the aphids had been identified as *Dilachnus piceae*, the food plant being spruce, it was determined that the closest possible point from which they could have originated was the Kola Peninsula in Norway—a distance of about 1300 km. This evidence generated speculation on the means of transport; 4 possibilities exist: (1) wind, flight, or both; (2) marine drift; (3) birds, or bats; and (4) man.

(1) *Wind, flight, or both.* Although not enough research has been done to determine the number of insects transported in a given volume of air or the circumstances under which they departed from their land bases, observers have sighted insects at sea in all types of weather (Carruthers 1889; Elton 1925; Heape 1931; Williams 1942, 1943; Johnson 1955; Darlington 1957; Andrewartha 1961). Several observations have been made which are helpful in trying to understand flight by insects over water. While flying in steady, moderate wind conditions, insects can only react as if they were flying in still air. This has been found to be true because the air and the visual field tend to move as a unit, with no velocities relative to each other. Insects flying over the sea, in almost any conditions, may be expected to show a strong tendency to continue in a straight line of flight. Only sudden weather changes, shipping and aircraft, the advent of other animals, and either land or exhaustion could change the continuance of effort (Hocking 1953). Heape (1931) reported that locusts travel by night as well as during the day and though they do not travel fast, swarms have been seen over the Atlantic 1900 km from land. There is also the possibility of insects using the surface of the ocean as a "resting" place. It is not known how common this phenomenon is, but observations of insects landing and flying away again were listed by Williams, 1930, and include: Thorncroft 1865, Buchenau 1872, Pocklington 1872, Chapman 1897, Tutt 1902, and Balfour-Browne reported by Poulton 1929a. Felt (1925a, 1928) reported butterflies, grasshoppers and dragonflies using the ocean as a place for landing, resting, and resuming flight. Walker (1931) indicated that some species are able to alight and rise again from the surface of a calm sea. Hocking (1953) stated that "there was no indication that any insect ever stopped flying on account of fatigue as distinct from exhaustion."

R. A. French & J. H. White (1960, 1961) have reported an observation from a ship 1600 km at sea of millions of tiny diamond-back moths. Apparently they had been going for at least 2 days nonstop, carried irresistibly by the wind at 32 km per hour, beating their wings all the time in order to stay up.

While the effects of wind will be more thoroughly reviewed together with weather later in this report, it has been generally agreed that the largest number of the species in the oceanic insect fauna has reached the various islands by aerial dispersal.

(2) *Marine drift.* Rafting with ocean currents includes single logs which have made the 16,000-km journey from South America to Australia (Barber et al. 1959), as well as

a whole "hillside" which had been undercut by a flooded river and carried out to sea (Darlington 1957). Wheeler (1916) reported live ants in a log from Brazil washed ashore on San Sebastian Island. Emerson (1955) stated that termites of the genus *Prorethra* have been transported to many islands in logs, and Schuchert (1935) reports that natural rafts originating in the Amazon and Orinoco Rivers have been noted as far as 1600 km out to sea, and lizards, snakes and even small mammals have been seen alive on such floating islands. There has also been some insect dispersal on floating ice (Elton 1925). In spite of the above data, marine drift has probably been the least successful method of insect dispersal.

(3) *Birds or bats*. Though ectoparasites form the largest group of insects transported across oceans by birds and bats, it has been proven that free living species also attach themselves to various parts such as feathers and feet and are transported great distances (Zimmerman 1948, Gressitt et al. 1964). Proof that long range transport by birds can actually take place is shown by the fact that a duck was shot in the Sahara at least 160 km from the nearest body of water with fresh mollusk spawn attached to one of its feet (Gislen 1947, quoting from Weber 1914). While this is not the most common method by which insects disperse across oceans, the possible speed (Nova Scotia to the Bahamas in 30 hr), distance (even pole to pole) and regularity make it a method not to be taken lightly (Schuchert 1935).

(4) *Man*. Previous to the wide usage of aircraft, insects transported by man could usually be separated from those transported by other means. Insects commonly dispersed by ships were mostly associated with man, agriculture and domestic animals (Gressitt & Yoshimoto 1963) and soon became cosmopolitan. In recent years there has been a definite increase in inter-island transfer of insects both inside and outside of aircraft. One of the earliest observations came in 1928 when the airship Graf Zeppelin made its first visit to North America; 7 insect species were found in bouquets decorating the cabins (Gislen 1947, taken from Johnston 1934). F. G. Whitfield gives a fairly complete summary of airplane dispersal of insects up to 1939, and since then, further reports have appeared (Pemberton 1944; Dethier 1945; White 1949; Dumbleton 1950; Laird 1951, 1952; Glick 1957, 1965).

To conclude this section on dispersal, a quote from Williams (1958) seems appropriate: "Thus we see that insects, in small or occasionally large numbers can survive over the sea journeys of up to a thousand miles, and still be alive and active at the end. The vast majority of such wanderers must eventually be lost at sea; others may come to a land of inhospitable areas where perhaps no food plant exists; those that have not already paired may be unable to find a mate when they come to land and so remain sterile. Others will reach outlying lands which have been reached before by similar wanderers and perhaps survive for a generation or two. Only very rarely will such great overseas movements result in the permanent establishment of the species in an entirely new part of the world. Most of the insects which have appeared in new areas in the past century have been transported by man-directed traffic and not by the long distance natural movement of the insects themselves."

When we consider the extent of geological time, the odds against long-distance over-sea dispersal are not too great, but the effect has been very selective. Thus some groups of insects are much more successful at over-sea dispersal, and some groups are almost ex-

cluded. This results in a very disharmonic fauna for a greatly isolated island which is biologically oceanic—that is, one which has been submerged or lava-covered if ever connected with a larger land mass (Gressitt 1956, 1961).

The study of aerial densities

Early studies of aerial densities and distribution included collecting from motor cars in Europe (Bonnet 1911), and nets on the fender of an automobile were also used to determine the relative abundance of insects in the United States (McClure 1938). Some mention is made of collecting from moving trains (Williams 1958). One of the first observations of insect at more than 300 m above the ground was made by F. V. Theobald during World War I when he found aphids sticking to parts of airplanes after flights. In a letter dated 2 February 1927, Theobald stated that following the above observations, a number of aphids were captured with sticky fly paper on an airplane flying at an elevation of 300 meters plus (Felt 1928).

According to Whitfield (1939), Stackman et al. (1923) were among the first to use aircraft in the study of aerial population. They found spores, fungi, small insects, pollen grains and glumes of grass up to 3300 m. Spores were found as high as 4850 m.

Felt (1928) was among the first to report on an airplane trap. It had a sectional area of some 20×25 cm. This device was attached to the lower wings of the plane (Curtis J. N.) and so arranged that glass slides smeared with tree tanglefoot could be exposed at given altitudes and for a definite length of time. Several flights produced insects, others did not. Perry A. Glick was the first to design and build a trap to screen an adequate volume of air. Trapping flights started in 1926 and the first results were published by Coad in 1931. A much more comprehensive report of this work supported by the U. S. Department of Agriculture was published by Glick in 1939.

Collins & Baker (1934) also carried out airplane trapping in the U. S., while Berland (1934, 1935) was one of the first outside the U. S. to use the airplane as a means determining insect densities at different altitudes. Charles Lindberg carried out investigations of microplankton over the ocean. In 1933, he flew between America and Europe. En route he crossed the inland ice or Greenland and exposed glass microscope slides at various times and at different altitudes. When examined, the sticky film contained not only microorganisms, but insect fragments and other small particles as well (Meier 1935).

The first estimate of the magnitude of aerial insect population was made by Coad (1931). He found that the number of insects in a vertical column of air 1 mile square (2.6 km sq.) and extending from 15–4300 m above the ground averaged 25,000,000 throughout the year at Tallulah, Louisiana, the population being lowest in January at 12,000,000 and the highest in May at 36,000,000. Details were not given.

After World War II, Prof. Hardy made experiments with nets trailing behind a helicopter flying over the English Channel at heights of 150–300 m, but the results were disappointing and were discontinued (Williams 1949b).

Odintsov (1960) stated that in the spring of 1958 a successful practical test was carried out on an entomological air trap mounted on an AN-2 airplane. He further pointed out that in the USSR no previous work had been done on collecting insects by traps installed on airplanes, but he quotes Reikhard (1941) as a reference on this point which is somewhat misleading.

The Bishop Museum devised and built a high speed airplane trap for air-borne organisms in 1960 (Gressitt et al. 1961). This device has been operated for 3 years at altitudes up to 6100 m. Results were summarized by Holzapfel & Gressitt (1965).

Regarding high altitudes, it would be appropriate to mention records of insects taken in mountains. Humbolt observed various insects at heights of 4800-5400 m in the Andes and ascribed their presence to currents carrying them up the mountainsides (Freeman 1945, quoting from E. Whymper 1892). Heape (1931) quotes from Major Hingston whose account in the Times (29 July 1924) states that butterflies were seen by members of the Everest Expedition, haunting glaciers and moraines at a height of 5200 m. Additional accounts were given by naturalists who accompanied the Mount Everest Expeditions of 1921 (Wollaston 1922) and of 1924 (Hingston 1925). Diptera frequented the cliffs at 4900 m; bees, moths and butterflies reached 6400 m, and spiders up to 6700 m. Regarding the latter, Hingston says, "We found traces of permanent animal existence far above the snow-line and 1200 m above the last vegetable growth." Gislen (1947) has reviewed the records published on expeditions to the tallest peaks in Africa and Asia; Williams (1958) did the same for Europe and Asia, but the most comprehensive book on the subject is Mani's "Introduction to High Altitude Entomology" (1962).

Weather

The diverse weather conditions under which insects are sighted at great distances from land lead to speculation on the effects of wind currents on the transport of insects. Guppy (1925) agreed that transoceanic distribution was carried out mainly in the upper air, but he doubted the possibility of the 3500-km North American-Hawaii dispersal.

In an effort to measure the effects of winds on inanimate objects, several balloon experiments have been conducted. Felt (1928) was one of the first entomologists to attempt to measure insect dispersal possibilities by this means. An excerpt from his publication indicates how much an insect might be aided by winds in his movements: "The balloon work of the New York State Conservation Commission indicated an average velocity for balloons recovered within 24 hours of the time of liberation in 1923 of a little less than 18 miles per hour, while one balloon covered 65 miles in an hour and another the same distance at the rate of 100 miles an hour. The longest drift in 1923 was nearly 400 miles, seven balloons covering from 110 to 145 miles. In 1924 the maximum was nearly 775 miles." Additional work was done by Gaines & Ewing (1938) who found that the maximum drift from their releases was 600 km which took 18 hours and 11 minutes, and 1 balloon drifted an average of 48 km per hour.

As knowledge of lateral and vertical movements of insects increased, it was found that surface wind currents are important in insect dispersal, and this is especially true with the smaller, weak flying insects. A brief review of certain meteorological points becomes necessary if one is to attempt to explain insect dispersal.

Wellington, in a series of papers in 1945, was one of the earliest workers to produce evidence in the lab that insects can survive at considerable altitudes. The following are excerpts from his work that tend to support the generally accepted theory of the early 1940's that widespread horizontal dispersal must result from organisms drifting to the earth from once attained high altitudes: "A vertical cross-section of the atmosphere shows that the normal environmental changes upward consist of decreases in the pressure,

temperature and moisture content of the air."

As a result of lab experiments on insects, it is evident that the decrease of atmospheric pressure may be safely neglected as either a limiting or a lethal factor among the elementary environmental changes experienced by insects distributed at higher altitudes. Temperature is a limiting factor in any attempt by an insect to reach higher altitudes by its own efforts, since it is obvious that no insect could continue to support itself by flight if it was cooled below its particular minimum flight temperature. Although low temperatures act as a limiting factor to flight, if the insect becomes inert and is passively carried to low temperatures by some strong convective process, the lethal or sterilizing effect of a subzero temperature would depend not so much upon the number of times that the inert insect is exposed to it by the moving circulation, but more upon the duration in minutes of any one such exposure, and also upon the relative humidity of the air. Soft-bodied insects are instantly rendered vulnerable to the cold by saturated air or by deposited surface moisture. Minor changes in relative humidity ordinarily seem to have slight effect upon the average insect under flight conditions, except in the above mentioned instance at freezing temperature when the air is saturated. Very low humidity may result in desiccation. While not adequately discussed by Wellington, oxygen deficiency together with its diffusion, density loss, and the relative weight of the insect to displaced air should also be taken into consideration.

With proof that insects reach high altitudes and survive reasonably well the meteorological conditions existing at such altitudes, workers speculated on how they attained these altitudes and, once attained, the relative lateral transport that could be expected. The power of rising air currents and winds to lift and carry small organisms is often underestimated (Darlington 1938, 1957). Thermal convective currents of warm rising air generated over land masses during the day are capable of carrying insects high into the air (Felt 1938; Wellington 1945; Zimmerman 1948; Laird 1952; Johnson 1960, 1963). These currents in the warmer parts of the earth may easily rise 4600 m (Felt 1928), although they are generally not strong above 300 m (Gislen 1947). According to Wellington (1945), convection is the only process by which insects attain considerable altitudes in the free atmosphere. It is possible to predict the altitudes attained by an analysis of the air mass characteristics, generalizing with cloud types. However, as a means of lengthy horizontal transport of insects, convection cannot be considered effective. While convection processes permit great vertical movement, the height attained by this process is dependent on strength and direction of horizontal winds and turbulence at various altitudes as well as by duration of locomotion by the insects themselves since most (especially the larger ones) must beat their wings if they are not to fall (Johnson 1963).

If an insect reaches the upper limits of the convective processes, chances are that it will be cooled below its minimum flight temperature. It will then fold its wings and act as an inert particle. Thereafter, a certain upward force must remain present, or the insect's body will start to fall, presumably at a terminal velocity equal to the force necessary to sustain it. This velocity will be greater at higher altitudes where the density and the viscosity of the air are less (Wellington 1945). Since there is nothing in the normal structure of an upper wind to indicate the carriage of an insect upward, the insect must be carried horizontally in a turbulent friction zone or begin its descent. Thermal convection by itself is not enough to maintain insects at high altitudes over long distances since there are always downdrafts as well as updrafts. It is suggested that the wind at

higher levels could be considered a horizontal distribution factor only if the temperature of the level is such that insects deposited there remain active enough to maintain altitude, or are at least capable of adopting a flight attitude. If the insect is inactive there must be updrafts of some kind (Wellington 1945; Hurst 1965).

The air currents existing at the time of dispersal must be studied to determine the source and route of air borne insects (Medler 1960). Height density studies of insects reveal that the general aerial population resembles a daily explosion, with millions of insects thrown up, often to great heights over land, followed by an almost complete settling out by nightfall (Johnson 1963). Insects being transported horizontally may drop to the ground due to any of the following conditions: exhaustion, termination of flight response behavior, being caught in a downdraft, being precipitated out with rain, or by being cooled and not falling into warmer air in which flight might be resumed. The latter 2 situations could readily occur if the warm air containing the insects was forced over a cold air mass at a frontal system and cooled due to expansion (Pienkowski & Medler 1963, 1964). The effects of vigorous convection currents was observed by Johnson (1963) who found locusts forming towering cumuliform swarms hundreds of meters high. When convection is low, the swarms become flat and remain near the ground. In general, smaller insects are more sensitive to air currents since their transport is much more passive.

Dispersal through air mass convection will usually be a shorter range process than dispersal through frontal convection because the life of airmass cumulus or cumulo-nimbus is relatively brief. Air mass convection probably stirs up and mingles contiguous populations rather than introducing distant populations. Dispersal through convective transport will generally have a greater effect on local populations than dispersal through turbulent wind transport. With the former a portion of a local population may be transferred from one area and deposited bodily in another, whereas turbulent wind transport tends to spread local populations over wide areas (Greenbank 1957). From the foregoing, a general conclusion may be drawn that insects are likely to gain height during the day over the land due to their own flight activity, the effects of convective currents and other turbulence in nature. These tend to fall steadily at night over land and by both day and night over the oceans.

Ordinary convection and accompanying turbulence are too gentle to transport insects great distances. Abnormal and irregular counter currents set up by cyclonic disturbances are much more likely to serve as successful agents in the dispersal of insects (Zimmerman 1948) since under atmospheric storm conditions, air currents are capable of lifting insects from continents and carrying them great distances not only over the land but far out over the oceans in a short period of time (Schuchert 1935; Gressitt 1960). Hurricanes, whose substance is warm tropical air, are born in low latitudes for the source of their strength is the sea, which feeds water vapor into the disturbance. The eddies of the westerly wind currents originate in high or middle latitudes and carry with them both polar and tropical air. Though they may generate tremendous winds, they do not pack the concentrated punch of the hurricane (Blumenstock 1959). The central updraft of a hurricane is very strong, and reaches thousands of meters high. Violent tornadoes are known occasionally to have been carried by even the outer winds of hurricanes. Similar secondary whirls, or tornadoes, varying in size and violence, are probably common near the centers of hurricanes (Darlington 1938).

Hurricanes occur at the rate of about 40 annually in the tropics and provide a dynamic means of disseminating organisms (Dunn 1951; Herring 1958). Since they generally follow the same general track, they tend to disperse insects in one direction. Thunderstorms may also act as a medium for the rapid distribution of numerous insects over a wide area (Wellington 1945). In the structure of a typical thunderstorm, there is a strong updraft in the front of each cell of the disturbance. This updraft is often observed from the ground as the wind which blows towards the approaching storm. Insects in flight when this updraft passes over an area may be drawn up into the storm. The high speeds and persistent nature of the updrafts in a convective storm may result in the transportation of insects to great heights, but rapid long distance movement is the result of passive transportation. Insects drawn up into a thunderstorm might be tossed out the sides or top of the cloud, be deposited with the rain in the central downdraft, or be carried in the storm until the convective cell collapses; however, deposition can always be expected to be patchy. The physical conditions which insects would have to endure inside a thunderstorm are not necessarily fatal unless the insects are carried to that part of the storm where they would be coated with a layer of ice (Wellington 1945; Henson 1960). Insects which are deposited after a mass flight are battered but often still quite active (Henson 1951).

Ship Trapping

Proof of the vertical movement of insects to impressive heights (Felt 1928; Coad 1931; Collins & Baker 1934; Berland 1934), their lateral dispersal across oceans (Elton 1925; Williams 1930; Walker 1931), and their observation by lighthouse keepers (Felt 1928) and lightship crew members in the English Channel (Dannreuther 1933) convinced Hardy and Milne that insect collecting from ships at sea should prove profitable, and in 1937 Hardy mounted muslin nets with an opening of 1-2 m diameter on the George Bligh's masthead about 12 m above sea level. When the ship was on station or traveling slowly, kites were flown with nets suspended at heights of 60-120 m. This method of collecting with nets suspended passively in the air from the guide wire of a kite provides good evidence that the insects at the time of their capture were being carried along by the prevailing air currents and that they were not engaged in making independent directional flights. Many insects were taken over the sea more than 160 km from land (Hardy & Milne 1937, 1938).

Following World War II, Prof. Hardy's work with dispersal was expanded to include towing nets from helicopters, but this method was soon discontinued due to poor results. The mounting of nets from masts of ships was resumed (Williams 1949b).

Previous to 1950, relatively little work had been done concerning dispersal of insects across the Pacific. Williams (1930) listed the records of migrant Lepidoptera, and Walker (1931) commented that in proportion to the vastly greater extent of the Pacific, the records of insects observed far out at sea are much less numerous than those amassed from the Atlantic. He tried to explain this by stating that enormous areas of this great expanse of water lies entirely out of the track of modern commerce, and such areas may not be visited by a ship for years.

Records of insect dispersal in the Pacific remained very limited until a program of zoogeography and evolution was started by the Bishop Museum under the direction of Dr

J. L. Gressitt. The major emphasis of this study was placed on comparing collections taken from oceanic islands with those from continents or islands which were connected by land bridges in recent geologic time; to understand the origins, developments and relationships of the insect fauna of the widely separated islands groups, the study includes the observation and collection of insects at considerable distances from land and at various altitudes above the ocean. A prerequisite to the success of such a comprehensive study must include study of the probable points of origin, the taxonomic position and the natural dispersing patterns of the collected insects and the coordination of this data with available information on present and past air currents.

Svend Horsted and Harry Knudsen contributed to this phase of Pacific zoogeography studies several years before Bishop Museum started its trapping. They used 2 conical metal nets aboard the Danish research vessel "Galathea" on a 21-month round-the-world oceanographic research cruise from October 1950 to June 1952 (Yoshimoto, Gressitt & Wolff 1962). The collection together with its data had remained unutilized at the Zoological Museum of the University, Copenhagen, Denmark for a number of years, before it was sent to Bishop Museum for study and reporting.

Actual collecting of insects by Bishop Museum from ocean going ships was initiated in the summer of 1957.

METHODS AND EQUIPMENT

Since the study of insects trapped aboard the "Galathea" has been closely tied to that of Bishop Museum, the equipment used on that expedition will be described first. Upon leaving Europe 2 traps were used. One was a conical metal net (1 mm mesh) in a partial metal frame which terminated in a glass jar protected by a metal housing (fig. 1). The diameter of the opening was about 75 cm and the length about 200 cm. It was placed

CONICAL METAL NET

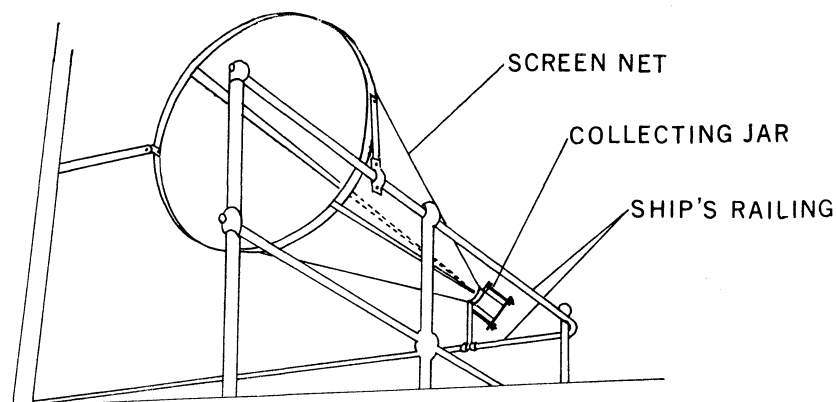

Fig. 1. Conical Metal Net—Designed for the "Galathea" cruise in 1950, its rigid mounting lacked the mobility necessary for efficient ship collecting.

horizontally on the upper bridge in free surroundings, facing the bow of the ship. Its fixed position reduced its collecting potential, and before the expedition was completed, its use was discontinued. The second trap was a conical metal net on a light frame with an opening diameter of 40 cm and a length of about 55 cm (fig. 2). A flange at the apex provided a fitting for a jar which was held in place by a metal plate and 2 wing nuts. This trap was fitted into an air intake on the main deck amidships. While at sea both nets were in operation and were checked twice daily. While trapping continued throughout the cruise, the accuracy of collecting diminished during turbulent weather, and no doubt some specimens were lost (Yoshimoto, Gressitt & Wolff 1962).

The initial premise when Bishop Museum started ship trapping in 1957 was that some insects far from land were traveling passively on wind currents at various altitudes. This premise, combined with the agreement that members of the military (M. S. T. S.) ship's crew would tend the collecting device while crossing the Pacific and provide necessary data, led to the design of equipment that would best meet these conditions and still withstand variable weather. A cubical aluminum frame screen "sticky" trap (fig. 3) was used exclusively the first year; each trap consisted of a metal frame in the form of a cube with 5 removable aluminum screens, each one-fifth of a square meter in area, and

AIR VENTILATOR SCREEN TRAP

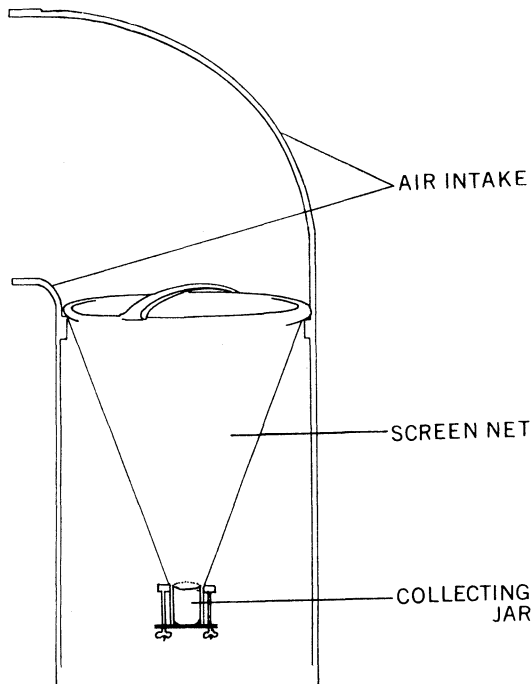

Fig. 2. Air Ventilator Screen Trap — The device used throughout the "Galathea" Expedition (1950-1952).

CUBICAL FRAME TRAP

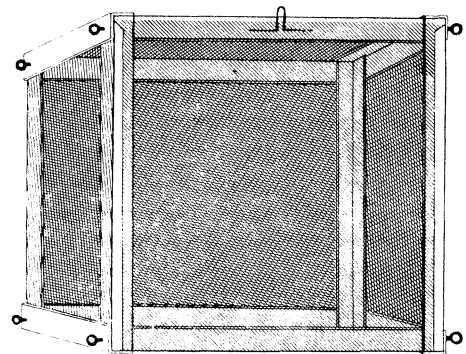

Fig. 3. Cubical Frame "Sticky" Trap — The Bishop Museum's first insect ship trapping collector.

fitting on the 4 sides, respectively, of the cubical frame, so that all sides and the top are effective trapping surfaces for all types of weather. The 5 screens are painted with an adhesive material. Resin-castor oil was used at first, but it was soon found that a mixture of "deadline" and resin-castor oil was better under the adverse weather conditions aboard ship. Forty-five extra screens, separated by individual slots and stored in a single $45 \times 50 \times 68$ cm aluminum box to prevent contamination, accompanied each trap; thus with 50 screens (44.3 cm^2) aboard, 10 collecting periods per cruise were feasible. Usually no screens were exposed for 24 hr immediately after leaving or before entering a port; however, once collecting was started, the screens were exposed for 24-hr periods, though on longer cruises such as to the Philippines the exposure periods were extended to 48 hr. Both screens and corresponding data sheets were returned to the Museum at the end of each voyage. A check trap was operated on the roof of the Museum simultaneously with the exposures at sea (Gressitt & Nakata 1958).

While the above cubical traps with screens continued to be used aboard M. S. T. S. ships in 1958, experiments were also tried aboard Coast Guard ships using fixed wind sock nets. One consisted of the end of a 25-cm diameter can with a vertical rod set in ball-bearings and evenly spaced hooks soldered on the back end. A medium weight muslin sleeve, 60 cm long, with grommets at the periphery of the larger opening, was attached to the hooks of the frame by a cord threaded through holes, and a 30-cm long, cone-shaped nylon net was fastened onto the other end of the sleeve by several buttons. A second fixed wind sock type trap (fig. 4) was made from a 50-cm diameter, 3×38 mm flat iron bar ring welded to two 38-cm bar strips at right angles. A heavy muslin sleeve, 60 cm long, with grommets was fastened by metal snaps onto the bar ring; on the opposite end, a 60-cm rounded apex nylon net was attached to the sleeve by buttons. The com-

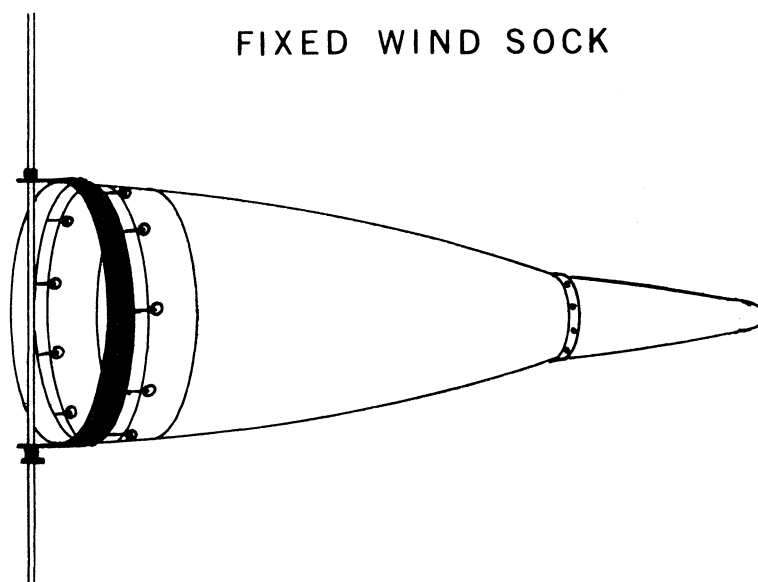

Fig. 4. Fixed Wind Sock Net—Used experimentally to determine the best configuration and size of net for insect collecting at sea.

plete wind sock frame was rotated on a 1.5-m vertical galvanized pipe lashed to a railing.

The nylon nets were first dipped into 5% endrin water mixture, then momentarily allowed to dry. Finally an aerosol spray containing DDT and pyrethrum was applied to the inside of the net. In order that the chemicals would have longer residual effect, the nets were stored in a closed container until used.

The procedure for exposing the screen traps aboard the Coast Guard ships was the same as for the M. S. T. S. vessels except that while on station Victor, a Coast Guard weather and rescue station located between the Hawaiian Islands and Japan, only 1 set of screens was exposed per week. A member of the ship's crew also changed the apex of the wind sock nets daily. When examination of insects taken from the aerial nets with a rounded

FREE WIND SOCK SUSPENSION SYSTEM

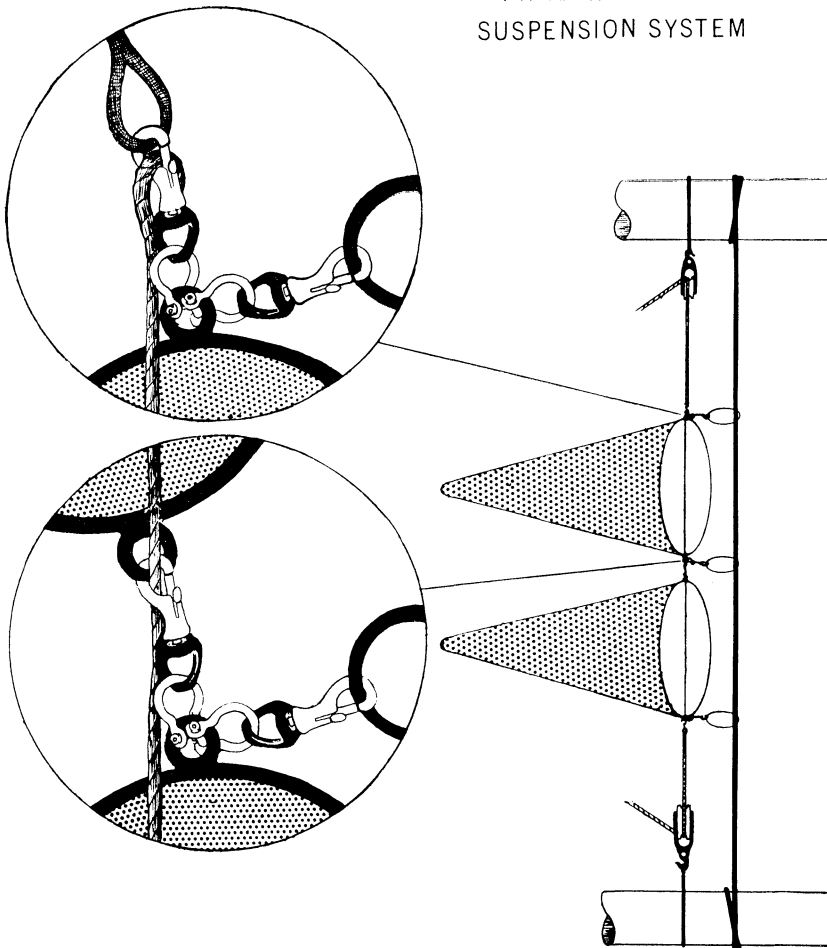

Fig. 5. Free Wind Sock Nets—Nylon cone nets with 1 meter openings have become the collectors by choice in the ship trapping program. A suspension system with guidelines provides needed support to the metal rings.

apex showed damage, their use was discontinued in favor of the cone-shaped nets. Another problem became apparent when the week-long exposure of the screen trap at station Victor dried the adhesive with the resultant loss of some specimens. (Yoshimoto & Gressitt 1959).

During 1959 the Office of Naval Research made it possible for an entomologist from the Museum to operate the equipment aboard the M. S. T. S. vessels. This permitted the aerial "fixed" wind sock type nets to be checked more than once daily. It also allowed a new "free" wind sock type (fig. 5) to be used experimentally, as well as a metal funnel type (fig. 6). While the screens were still used, they were found to be less efficient because they permitted not only 1 sample during a 24-hr period, but also their operation from the deck allowed more contamination from the ship than the aerial nets, the various adhesives were not all-weather, and they caused damage to the insect parts upon removal.

The "free" wind sock net consisted of a ring made of #10 galvanized wire which formed the mouth for the new nets which had a 75-cm diameter opening made of heavy muslin and a 1.5-m long nylon cone. Nets, 2 m long with a diameter opening of 1 m, were also tried. The rings of 2 nets could be joined together by U-bolts and 2 opposing small ringlets (fig. 5). The nets were then raised some 6-12 m above the main deck by attaching them to a line and pulley fastened to some part of the ship's superstructure as far forward as possible. Five to 8 nets could be flown in series. Later in the year a removably apex attached by buttons or snaps was also tried; the nets were checked by lowering them to the deck and removing the contents of each with a hand aspirator, and the material collected was transferred to vials. These free wind sock nets proved quite successful, though the nylon was unable to withstand winds above 35 knots for long periods. Extremely variable winds would also result in the loss of some specimens.

The metal funnel (fig. 6) had a 60-cm diameter inlet and was 1 m long. A curved apex was terminated by a soldered jar lid to which could be attached an upright jar half filled with an alcohol-glycerin preservative. A fin riveted to the metal cone kept the mouth of the funnel facing into the wind. Fine brass screening on parts of the cone apex and neck allowed the air channeled into the funnel to escape. Although the trap revolved on an aluminum pipe support, both high and low winds, rain, and its operation from the deck made it less efficient than the nylon nets.

Only 1 screen trap was used aboard the Coast Guard vessels in 1959 and the operating procedures were the same as the previous year. Collecting was also done on U. S. Fish

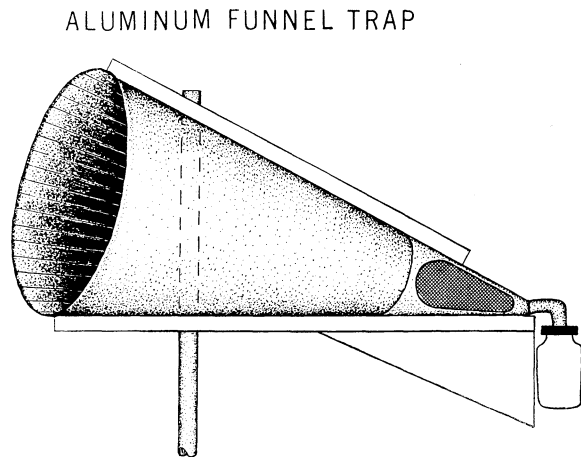

Fig. 6. Aluminum Funnel Trap—Its rigidity proved unfeasible during adverse weather.

and Wildlife Service vessels of the Bureau of Commercial Fisheries, Hawaii area (then Pacific Oceanic Fisheries Investigations or P. O. F. I.). In this phase of ship trapping, a single fixed wind sock net was checked daily by a crew member (Yoshimoto & Gressitt 1960).

The fall of 1959 also marked the beginning of insect trapping at sea in the Antarctic area aboard U. S. Navy vessels (U. S. Antarctic Research Program). Only the "free" wind sock type nets were used, though iron rings with diameters of 61 cm, 75 cm, 91 cm, and 1 m were experimentally used with frames 125 cm square. Some nets of the latter size, which were 3 m long, were supported by cords instead of metal frames. Ice, snow and frequent stormy conditions hindered the program by damaging nets at times making it impossible for the technician to operate the equipment.

In 1959, trapping commenced from DeHavilland Otter aircraft based in Antarctica (Gressitt, Leech & O'Brien 1960). Some test flying was done in Hawaii preceding this from Cessna planes and (Marine Corps) helicopters (latter using the 125 cm sq. nets).

Ship collecting in 1960 continued to be conducted with a technician on board. The use of both the sticky screens and the "fixed" nets were discontinued. The metal funnel trap was in operation early in the year, but a storm damaged it beyond use; thus, only wind sock type nets were used. Terminal nylon cones attached by snaps were used experimentally in an effort to facilitate the removal of insects from the nets. Steel replaced galvanized iron in the rings and the 75-cm diameter became the preferred size (Yoshimoto & Gressitt 1961).

Ships involved in the Antarctic program were used again in 1960 (Gressitt et al. 1961), and a program was also started aboard a Scripps Institute of Oceanography vessel in late August which carried the trapping of insects at sea into the Indian Ocean for first time (Gressitt, Coatsworth & Yoshimoto 1962). Nylon nets on metal rings were the only collecting equipment used in both the Antarctic and Indian Ocean areas, though their rigging aboard ship differed.

While the trapping of insects from Otter planes was discontinued in 1960, the studies of vertical insect dispersal was improved by a high speed airplane trap mounted aboard a Super Constellation (Gressitt et al. 1961).

With the damage of the metal funnel trap early in 1960, the entire program in 1961 relied on the use of nylon nets on steel rings with diameters of 75 cm and 1 m. Collecting continued in the Pacific, Antarctic and Indian Ocean areas. The airplane trap was also in frequent use (Yoshimoto, Gressitt & Mitchell 1962). In 1962, programs continued in both the Pacific and Antarctic areas. One major new concept was introduced in the Pacific when electric power suction traps were experimentally used for the first time. Two traps were produced and operated concurrently at sea. One was 2 m high with a cylinder 25 cm in diameter and a square base of 75 cm on each side. A 1/20 horsepower roof ventilator motor with a 24.4-cm fan provided a continuous suction while the trap was in operation.

The second suction trap (fig. 7) stood 2.5 m high. The aluminum cylinder was 90 cm in diameter and housed a conical nitex (#308) funnel-shaped net which guided all particles into a vial placed in a solid sliding plastic receptacle. This sliding plastic key, which guided the vial to the apex of the nitex net during operation, could be easily removed and the contents of the vial checked without disturbing the large upright cylinder. Below this collecting portion of the device was a tube axial fan with a 1-horsepower,

SUCTION TRAP

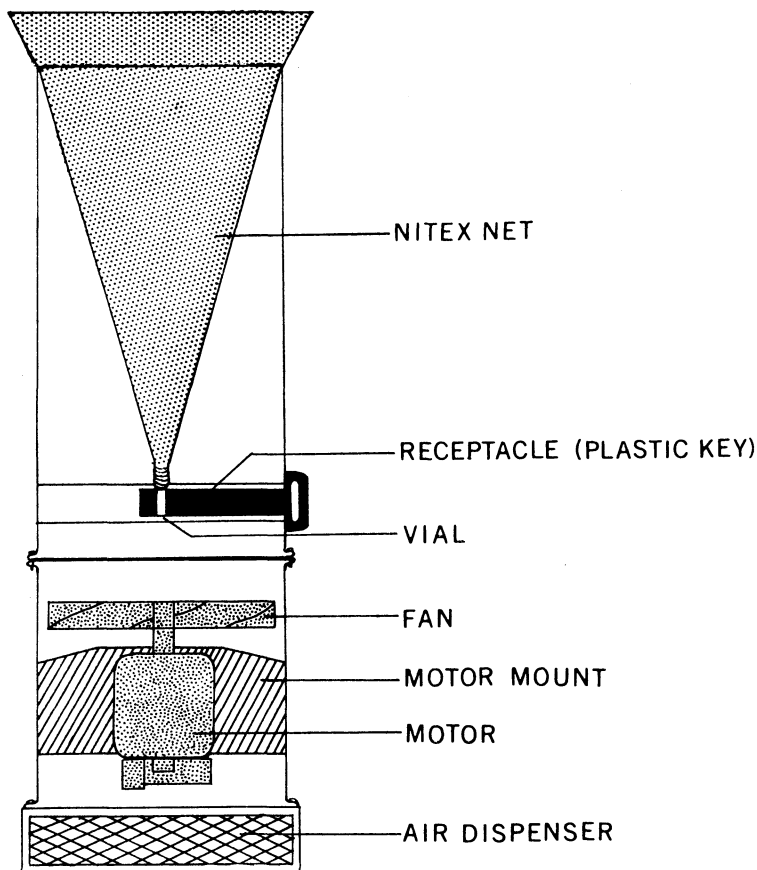

Fig. 7. Suction Trap—Development of a motor-driven collector resulted from the failure of other samplers to function properly during storms.

1-phase, 115–230 volts, 9.4–4.9 amps, 60-cycle electric motor mounted in a fan motor housing unit. This was bolted to the aluminum cylinder and the metal frame base air dispenser. The motor drew about 6800 m³ of free air per hour through the net, screening out all insects and particles. Specimens were recovered from the replaceable vial of the larger trap by use of a hand aspirator. During the first cruise it was found that the fan tended to reverse its motion, when the relative wind rose above 20 knots (Yoshimoto, Gressitt & Mitchell 1962), “fresh breeze” force (see fig. 10) on Beaufort Scale. Use of the 25 cm diameter suction trap was discontinued after the initial cruise proved it failed to function as successfully as the larger device, but the reversing motion of the larger fan in high winds was partially corrected by reducing the air dispensing unit below the the motor housing to 15 cm. A metal hood (air scoop, fig. 8) was also added which partially covered the top and vented a stream of air for a radius of 40 cm from above

the center of the cylinder down through the upright collector, thereby increasing the total volume of air sampled. This new scoop included a vane which allowed it to face constantly into the wind. A series of rollers attached the hood to the cylinder (Yoshimoto & Gressitt 1963).

While the collecting in the Indian Ocean terminated during the spring of 1961, the Antarctic program expanded into the Atlantic for the first time in the fall of 1962. A ship of the British Antarctic Survey was used and collecting started near England, visited South America and terminated in South Georgia. The nylon free wind sock nets with 75-cm steel rings were used exclusively on this voyage (Clagg 1966). Sampling at higher altitudes using the high speed airplane trap continued (Yoshimoto, Gressitt & Mitchell 1962; Holzapfel & Gressitt 1965).

AIR INTAKE --- SUCTION TRAP

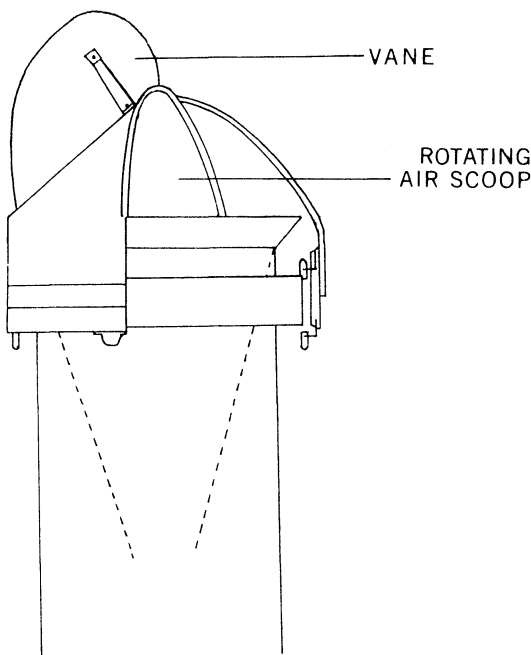

Fig. 8. Air Scoop—This is placed atop the suction trap to increase the volume of air screened.

to both sides of the nets as they were flown in series (fig. 5.). The cables were fastened to the superstructure of the ship above and to the deck below. Shackles and metal snaps were used to fasten the outer points of the metal rings to the cables. This made it easier to raise and lower the nets for checking during high winds, and it also relieved much of the stress on the relatively weak metal rings (Yoshimoto & Gressitt 1963). One obvious disadvantage was the limited ability of the nets to shift into the wind. Since some insects collected in the program had been those being transported by the ship, nets were experimentally flown from the signal halyards above the bridge in an effort to screen only those migrating or being carried passively by the wind.

By 1963 the use of the nylon nets on 75-cm diameter rings had become standard in both the Pacific and the Antarctic areas. Use of nets with detachable cones was discontinued and the rings were modified with a locking break which allowed the easy replacement of damaged nets. Previously, the nets had to be hand sewn to the rings aboard ship each time one had to be replaced. This new improvement required the ring to be cut at a point a 1.27-cm sleeve with a .318 cm hole bored and threaded in 1 end, was welded to 1 side of the cut ring. The other cut side of the ring had a .318-cm hole bored and threaded in it. After the net opening had been threaded over the broken ring, the break was "repaired" by inserting the side with the bored hole into the 1.27 cm sleeve and fastening the 2 by .318 cm screw (Harrell & Yoshimoto 1964).

Another improvement aboard ships in the Pacific came with the use of steel cables which acted as guide lines

First use of the suction trap with its air scoop (fig. 8) was made in January 1963. The need to change the nitex net at sea led to the addition of a small hinged door (25×25 cm) on the side of the upright cylinder wall. Through the hatch the apex of the net could be fastened to a metal tube which channeled the collected material into the vial below. This trap was especially productive since it could be operated even in winds exceeding 50 knots (see fig. 10) (Harrell & Yoshimoto 1964).

Collecting at sea in the Pacific during 1964 made use of the modified free wind sock nets with guide cables. Though no new collecting equipment was introduced, use of the modified suction trap continued (Harrell & Holzapfel 1966). Use of the 75-cm diameter modified rings was started in the Antarctic. Two Atlantic cruises were taken in 1964 and 1 in 1965 (Clagg 1966). Airplane trapping remained grounded during 1964 and 1965.

In 1965, nitex (#308) nets were used experimentally for the first time on the 75-cm diameter rings. These proved a definite advantage since they could be used during storms in which the nylon nets would be destroyed by winds in excess of 35 knots.

As the emphasis shifted from collecting of a qualitative nature to one in which the quantitative approach became more important, several factors not previously considered had to be taken into account. Freeman (1945) outlined some of these in reporting collections taken from nets flown from radio towers. He stated that the actual number of insects taken in the nets cannot be simply compared from catch to catch, since the wind speed and the time exposure of the nets are not constant. The wind velocity may also increase with height (this is especially true with the Museum's ship trapping since the bow of the ship and various structures on the main deck cause variable and irregular wind currents). Another factor was that the nets were found by experiment to filter only 80% of the air passing them.

With these points in mind, 2 basic changes were made to the ring nets. An all-aluminum 11.3-cm lip was designed which attached to the existing 75 cm diameter rings (fig. 9). Braces were built into this extension which permitted the inclusion of anemometer cups. In order to increase further the percentage of air screened as it passed the nets, an experimental nitex cone was tried which included a muslin sleeve of 75-cm diameter, opening to 1 m and then decreasing to 75 cm where it attached to the nitex cone.

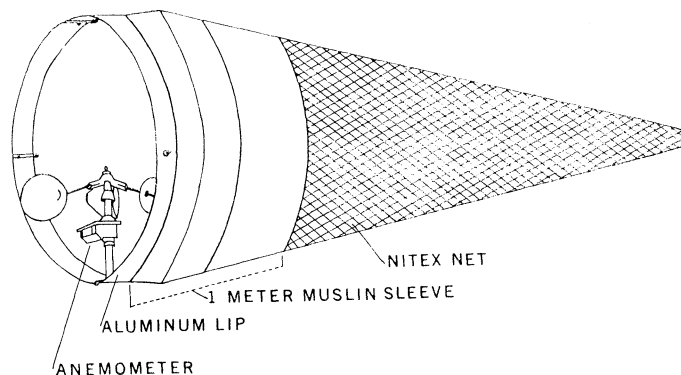

Fig. 9. Modified Free Wind Sock Net—Designed to increase and record the quantity of air screened.

To minimize the trapping of insects being transported by the ship, in 1963 several nets were flown from the halyards above the bridge normally used for signal flags while entering and leaving ports. This increased distance above deck reduced the amount of debris normally removed from the nets when flown from the mast-head, and in 1965 a semi-permanent cable was added in this new location to support a full series of nets. A further check of insects being transported by the ship was made by comparing those taken from the collecting devices above deck with those taken below deck in a portable light-fan trap operated in various compartments most likely to harbor insects. A slight modification was also made to the suction trap when it was discovered that strong winds could pin specimens to the sides of the sloping net, releasing them after the winds receded. Metal baffles were added inside the aluminum cylinder which redirected the airflow.

During 1966, plans were made outlining an expanded program of quantitative study. No trapping was done in either the Pacific or the Atlantic areas. Some cruises were taken in the Antarctic but no new equipment was used. The program has resumed in 1967 in an effort to determine the number of insects in measured volumes of air. While continued use is made of the 75 cm diameter rings and nets, new devices are planned, that will be capable of operating efficiently in all types of weather. To date, results have been questionable during heavy rains and snow and when the relative winds surpass 50 knots. In the design of new equipment, ship aerodynamics will be considered. Attempts may be made to sample isokinetically, applying the principles used by Johnson (1957) and Taylor (1962). Modifications were made to the airplane trap in 1966. It was mounted on a Pacific Missile Range aircraft based at Point Mugu, California and is now being operated to many points in the Pacific.

RESULTS

Between 1957 and 1966, records of over 13,000 specimens collected aboard ships at sea have been published by Bishop Museum. These reports include collections taken from the Galathea Expedition of 1951-52 as well as cruises arranged by the Museum in the Pacific, Antarctic, Indian and Atlantic Oceans from 1957 through 1954.

Two classes, Arachnida and Insecta, are represented. Of Insecta, 16 orders and 193 families were collected. The order with the greatest number of specimens (6063) is Hemiptera; next is Diptera (5161) which has the largest number of families (42) represented. The largest number of specimens (1886) in a single family is Aphididae; the second largest is Drosophilidae (Diptera) with 1514 specimens. Of the 193 families, 107 are represented by 5 specimens or less in each family. Four families have over 1000 specimens each. Table 1 contains a breakdown by families of all the specimens collected, 1957-1964. The Museum has compiled a list of all the specimens collected during the 7 years of the program. This list contains the location, number, weather and other pertinent remarks concerning the collection of these specimens. The list is divided into the major orders collected (copies or sections of it may be obtained by writing to the Entomology Department, Bishop Museum).

Because of the large number of specimens collected under different conditions aboard various types of vessels, it is impossible to attempt a comprehensive summary of the total results of the program. While Map 1 gives some indication of specific points at which specimens have been recovered from the nets, no attempt has been made to include the

Table 1. Ship trapping specimens compiled by order and family (1957-1964).

COLEOPTERA	241	Derbidae	32	Piophilidae	12
Anobiidae	1	Fulgoroidea	1459	Psychodidae	10
Anthicidae	1	Gerridae	229	Sarcophagidae	8
Anthribidae	8	Jassidae	24	Scatopsidae	29
Bruchidae	3	Lygaeidae	56	Sciaridae	52
Buprestidae	2	Mesoveliidae	8	Sepsidae	4
Cantharidae	1	Miridae	141	Simuliidae	1
Carabidae	16	Nabidae	34	Sphaeroceridae	36
Cerambycidae	1	Pentatomidae	8	Stratiomyiidae	1
Chrysomelidae	11	Ploiariidae	1	Syrphidae	4
Cleridae	4	Pleidae	1	Tachinidae	1
Coccinellidae	24	Psyllidae	250	Tipulidae	219
Colydiidae	1	Reduviidae	1	Trixoscelidae	1
Cryptophagidae	1	Saldidae	1	Trypetidae	25
Cucujidae	3	Tettigellidae	11	Fragments	8
Curculionidae	6	Tingidae	2	Unknown	791
Cybocephalidae	3	Veliidae	10		
Dermestidae	1	Fragments	31	HYMENOPTERA	
Dytiscidae	9	Unknown	442	Agaontidae	344
Gyrinidae	1			Apoidea	2
Haliplidae	1	DIPTERA	5161	Bethylidae	2
Hydrophilidae	13	Acalyptratae	9	Braconidae	75
Lathridiidae	11	Agromyzidae	235	Cephidae	1
Mycetophagidae	2	Anthomyiidae	29	Ceraphronidae	4
Nitidulidae	19	Bibionidae	13	Chrysididae	1
Noteridae	1	Borboridae	70	Cynipidae	16
Oedemeridae	1	Calliphoridae	12	Elasmidae	1
Orthoperidae	4	Canaceidae	4	Encyrtidae	24
Pselaphidae	1	Cecidomyiidae	191	Eulophidae	84
Ptiliidae	1	Ceratopogonidae	300	Eupelmidae	1
Scaphidiidae	1	Chironomidae	812	Eurytomidae	2
Scarabaeidae	7	Chloropidae	73	Figitidae	2
Scolytidae	7	Coelopidae	8	Formicidae	201
Scydmaenidae	1	Culicidae	43	Ichneumonidae	11
Staphylinidae	36	Dolichopodidae	34	Mymaridae	18
Tenebrionidae	3	Drosophilidae	1514	Perilampidae	6
Unknown	34	Empididae	4	Platygastridae	6
Fragment	1	Ephydriidae	288	Proctotrupidae	11
		Helomyzidae	2	Pteromalidae	45
HEMIPTERA	6063	Lauxaniidae	11	Scelionidae	26
Aleyrodidae	17	Leptoceridae	14	Torymidae	2
Alydidae	1	Limoniidae	1	Trichogrammatidae	4
Anthocoridae	2	Lonchaeidae	1	Vespidae	1
Aphididae	1886	Milichiidae	143	Fragments	1
Cercopidae	1	Muscidae	17	Unknown	22
Cicadellidae	1404	Mycetophilidae	24		
Coccidae	1	Nematocera	1	LEPIDOPTERA	226
Coreidae	3	Opomyzidae	33	Arctiidae	1
Corixidae	7	Phoridae	73	Blastobasidae	23

Coleophoridae	1	ODONATA	22	COLLENBOLLA	4
Epermeniidae	1	Coenagrionidae	2	Poduridae	1
Gelechiidae	31	Libellulidae	14	Tomoceridae	1
Geometridae	4	Zygoptera	5	Unknown	2
Hesperiidae	1	Unknown	1		
Lyonetiidae	2			ANOPLURA	1
Microlepidoptera	38	ORTHOPTERA	16	Unknown	1
Noctuidae	19	Acrididae	3		
Notodontidae	1	Blattidae	1	ACARINA	16
Nymphalidae	2	Gryllidae	2	Ascidae	1
Oecophoridae	2	Mantidae	1	Bdellidae	1
Opostegidae	5	Tettigoniidae	8	Eupadidae	1
Phycitidae	1	Unknown	1	Oribatidae	3
Pterophoridae	7			Parasitidae	1
Pyralidae	41	DERMAPTERA	1	Tyroglyphidae	1
Pyromorphidae	1	Unknown	1	Uropodidae	1
Sphingidae	1			Unknown	7
Tineoidae	1	PSOCOPTERA	59		
Tortricidae	2	Coesciliidae	11	ARANEIDA	275
Fragments	2	Ectopsocidae	6	Agelenidae	2
Unknown	39	Lachesillidae	1	Argiopidae	2
		Liposcelidae	9	Linyphiidae	3
EPHEMEROPTERA	1	Mesopsocidae	2	Lycosidae	4
Palingeniidae	1	Peripsocidae	6	Oecobiidae	1
		Psocidae	2		
NEUROPTERA	44	Psoquillidae	4	SOLPUGIDA	1
Berothidae	3	Unknown	18	Salticidae	1
Chrysopidae	10			Unknown	261
Coniopterygidae	1	THYSANOPTERA	94		
Hemerobiidae	7	Thripidae	76	TRICHOPTERA	2
Myrmeleontidae	9	Unknown	18	?	1
Sisyridae	1	ISOPTERA	6	?	1
Unknown	13	Rhinotermitidae	5	UNKNOWN ORDER	5
		Unknown	1		

contents of Table 1, nor unreported specimens taken aboard ships in the past few years.

As an example of the whole program, 3 separate collections from 1 area were examined. These collections in the Yellow Sea area were chosen because in each instance a large and varied sample was collected at different times of the year and under different weather conditions.

Before examining the weather conditions during these cruises, it should be noted that all specimens discussed were collected in the "free" wind sock nets. A review of the taxonomic grouping of the specimens is also desirable. A series of maps has been prepared for each cruise to illustrate the area and weather conditions during the period of collecting, as well as the ship's movement. (See fig. 10 to interpret wind velocities and directions indicated by arrows on the maps.)

During the first cruise to be considered, 59 specimens representing 6 families and 3 orders were collected on 30 April 1960 aboard the *USNS Barrett*. The first series of maps

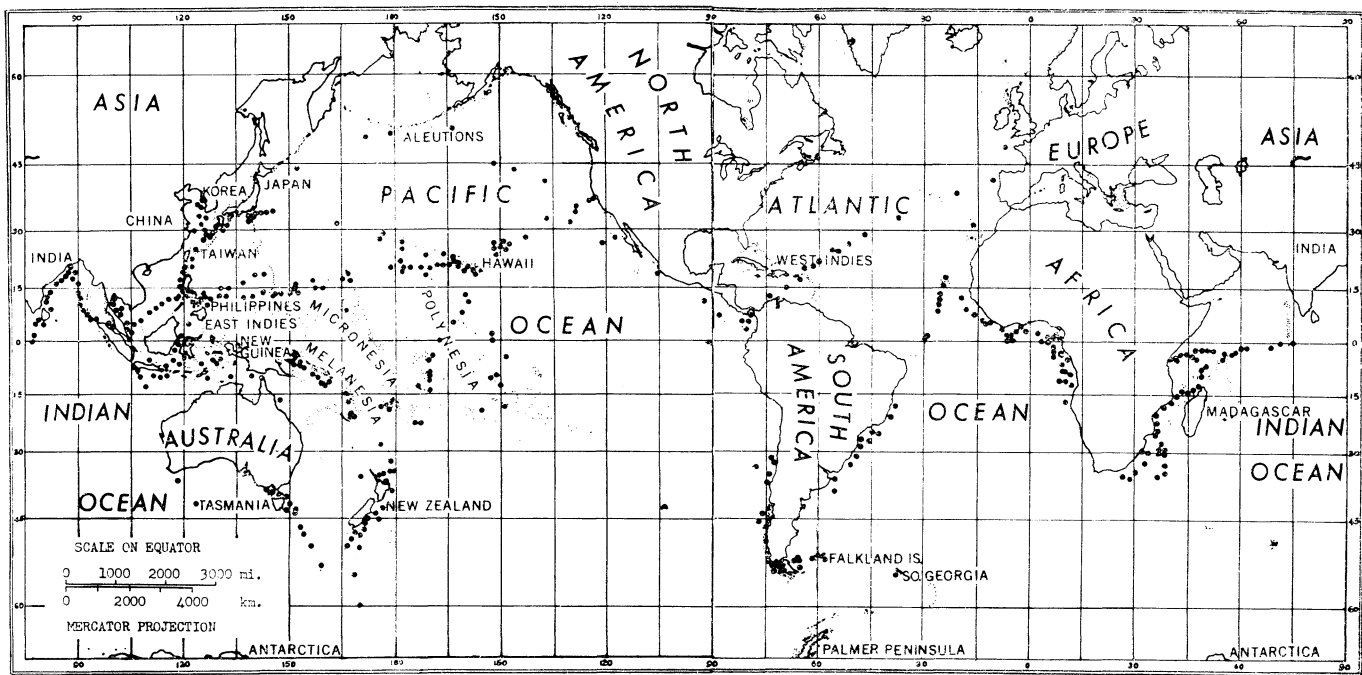

Map 1. Ship trapping of airborne insects at sea has been world-wide. Black dots indicate areas from which specimens have been recovered.

Estimating winds on the beaufort scale













Beaufort number	mph	knots	Description	Observation	Symbols on Weather maps
0	0-1	0-1	calm	smoke rises vertically	 calm
1	1-3	1-3	light air	smoke drifts slowly	 calm
2	4-7	4-6	slight breeze	leaves rustle	5 knots 
3	8-12	7-10	gentle breeze	leaves and twigs in motion	10 knots 
4	13-18	11-16	moderate breeze	small branches move	15 knots 
5	19-24	17-21	fresh breeze	small trees sway	20 knots 
6	25-31	22-27	strong breeze	large branches sway	25 knots 
7	32-38	28-33	moderate gale	whole trees in motion	30 knots 
8	39-46	34-40	fresh gale	twigs break off trees	35 knots 
9	47-54	41-47	strong gale	branches break	45 knots 
10	55-63	48-55	whole gale	trees snap and are blown down	50 knots 
11	64-72	56-63	storm	widespread damage	60 knots 
12	73-82	64-71	hurricane	extreme damage	70 knots 

Fig. 10. The international Beaufort Wind Scale indicates wind velocities and direction. Velocity scale and description are given here. Wind direction is determined by the position of the "arrow" on the map. That is, if the arrows were seen on a map in the same positions as shown here, the wind would be from the west blowing to the east.

(2-6) helps to clarify conditions on that date while the second series (7-10) presents the picture on 15 May 1962 when 22 specimens representing 7 families and 4 orders were collected in the same area and on the same ship. On these 2 cruises only 2 of the 13 families (Aphididae and Drosophilidae) are the same which leads one to speculate that they may have originated from a totally different type of terrain.

The third series of maps (11-17) presents conditions on 6 & 7 October 1963 at which time 3051 live specimens representing 10 orders and 41 families were collected aboard the *USNS Gaffey*. Since an unusually large number of specimens (2951) was recovered on these 2 dates, the ship's course has been divided into Leg A with 2256 specimens and Leg B with 695.

Of the 13 families collected on the 2 different occasions on the *Barrett*, 4 families were not collected on the *Gaffey*. All of the 7 families collected on the *Barrett* in May 1962 are represented in the October 1963 *Gaffey* collection. The largest group collected in March 1960 on the *Barrett* was Milichiidae with 54 specimens. But not a single specimen of Milichiidae was taken during May 1962 or in October 1963. Of the 4 Diptera families collected in March 1960, only 1 family (Drosophilidae) was collected both in May 1962 (1 specimen) and on Leg B in October 1963 (45 specimens).

On Leg A of the *Gaffey* collection, 28 families are represented; on Leg B, 31 families. Of these 31 families, 13 were not collected on Leg A; 9 of these 13 families were Diptera. On Leg A, only 7 families were not also collected on Leg B. Of special interest is the large number of Drosophilidae (45) and Culicidae (28) collected on Leg B, but not on Leg A. This may again point to different origin. On Leg A, Aphididae with 686 specimens, Cicadellidae with 478 and Delphacidae with 439, were the most numerous families collected. On Leg B 200 Aphididae, 168 Cicadellidae and 41 Delphacidae were taken.

The weather information plotted on the following series of maps for the Yellow Sea area was taken from the U. S. Weather Bureau synoptic surface charts for the Pacific on the corresponding dates of the 3 collections. These charts are prepared every 6 hours, starting at 0000 hr G.M.T. All U. S. Weather maps for the Pacific are based on G. M. T. time. Since local times are used in the text, G. M. T. has been converted to local time on the maps used here. Standard weather symbols, and isobar locations were drawn, as well as the ship's movements through the Yellow Sea.

The specimens collected on the *Barrett* cruise in March 1960 were removed from the wind socks at 0800 on the 30th. The wind was blowing from the W at 15 knots. To reach this position from the Chinese coast line, these specimens would have had to be airborne between 1400 and 2000 on the 29th, since it would take the specimens 11 hours to travel the 32 km distance, at an average speed of 15 knots per hour.

The first map series (2-6) shows the weather conditions over the Yellow Sea area at 1400 on 29 March (Map 3). At this time a low pressure area was developing over the Wei-hai-wei Peninsula. The wind was blowing towards the Peninsula from the SE (160°) at 2.5 m/sec. (5 kn.). By 2000 on the 29th (Map 4) a low pressure area formed over the Yellow Sea just E of the Wei-hai-wei Peninsula. Resulting winds blew from the NW (325°) towards a weather front that crossed the Yellow Sea, bisecting the low pressure area. This front and the low pressure area were moving SE towards the tip of South Korea. The temperature over the Wei-hai-wei area had risen from 10°C to 14°C

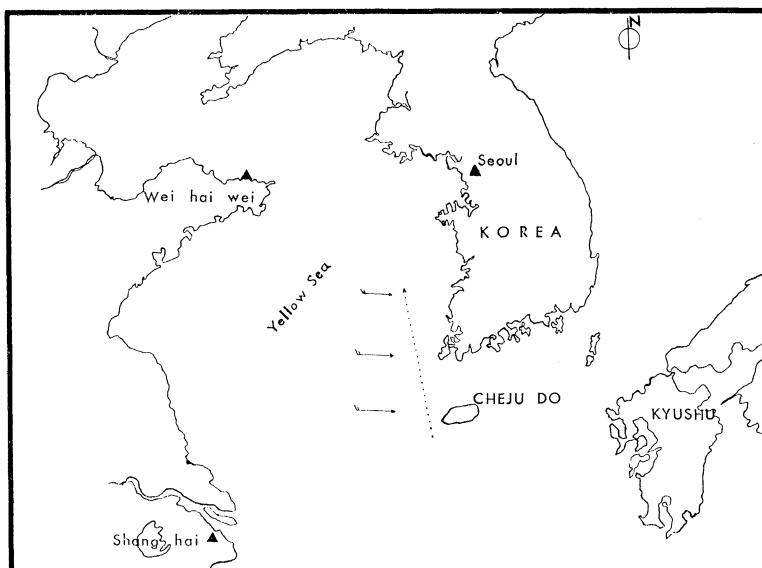

Map 2. Insect collecting in the Yellow Sea was done along the course line shown by the dotted arrow shaft, from south to north on 29 & 30 March 1960. Beaufort Wind Scale arrows indicate that moderate westerly breezes of about 15 knots prevailed during the two days. (See Maps 3-6.)

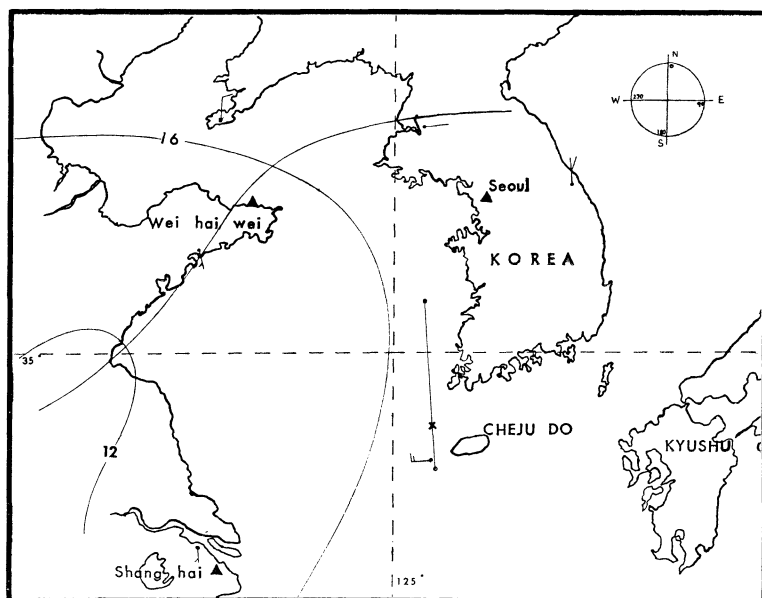

Map 3. Weather conditions over the Yellow Sea at 1400 hr on 29 March 1960. The trajectory shown here from available weather information indicates this to be the approximate time the insects collected at 0800 on 30 March departed land.

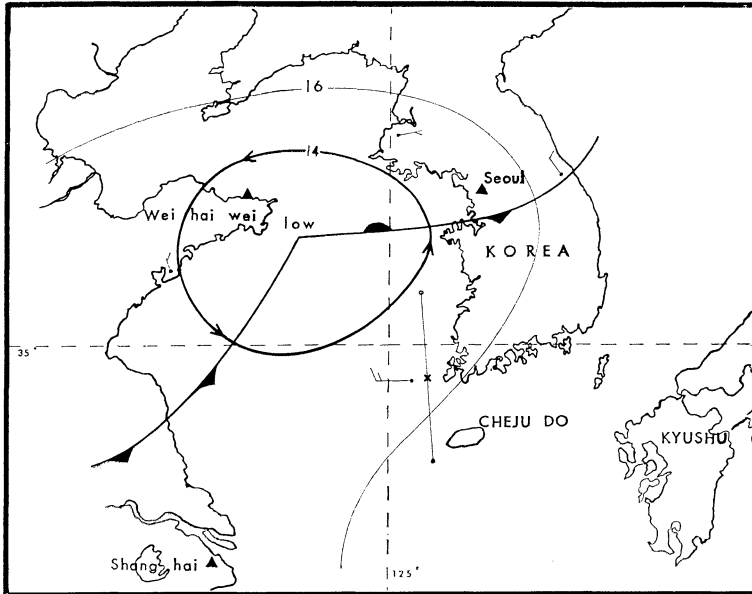

Map 4. The rise in temperature caused by the passage of the frontal system about 2000 on 29 March may have created convective air currents over the Wei-hai-wei Peninsula adequate to lift insects to higher air flows.

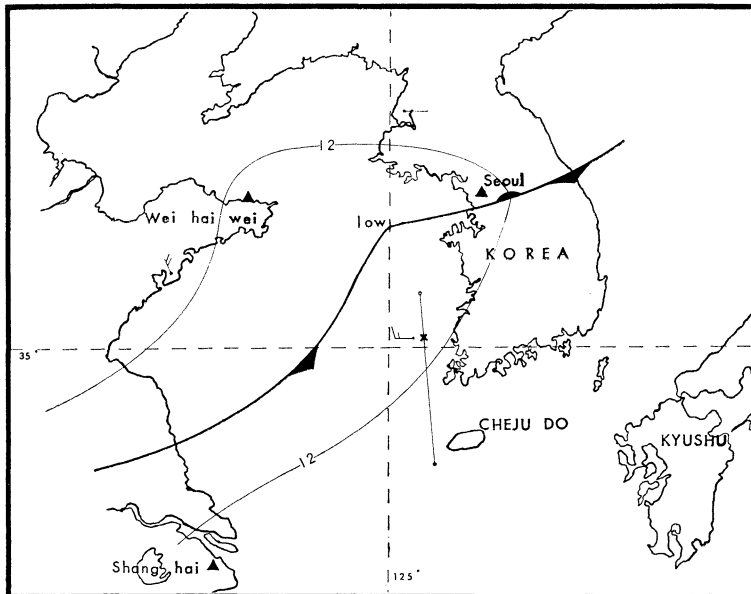

Map 5. By 0200 on 30 March the frontal system had moved eastward, and the wind in the Wei-hai-wei area had increased slightly.

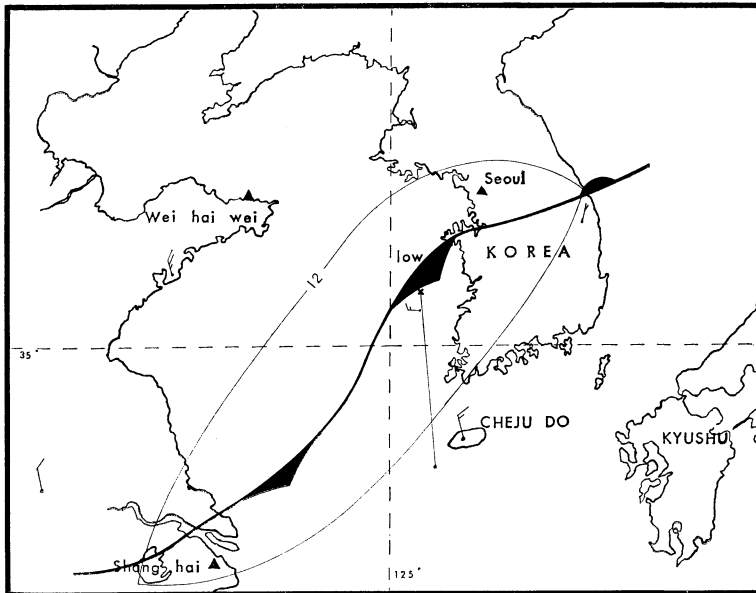

Map 6. The ship and the frontal system intersect by 0800 on 30 March. It is postulated that the insects collected at that time had been carried from the China mainland by this front.

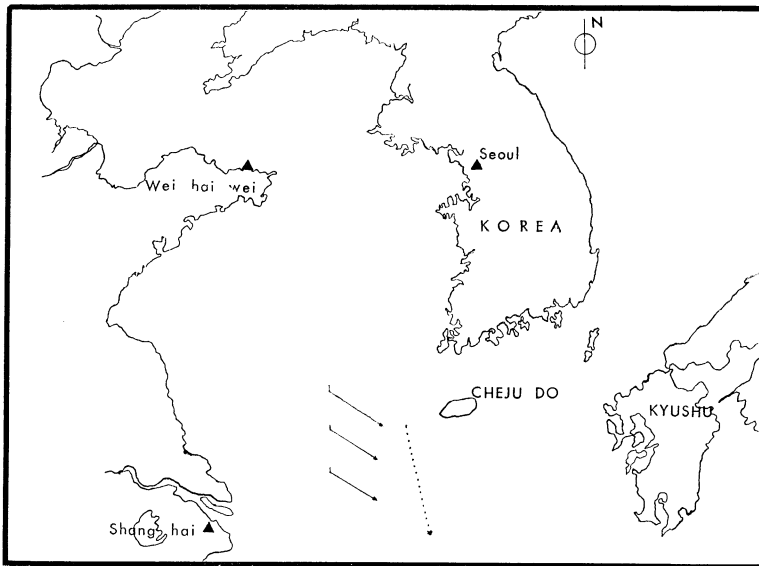

Map 7. Insect collecting was done along the course line shown by the dotted arrow shaft, from north to south on 15 May 1962. Wind arrows indicate that a gentle northwesterly breeze of about 10 knots prevailed along the ship's course during the collecting period. (See Maps 8-10.)

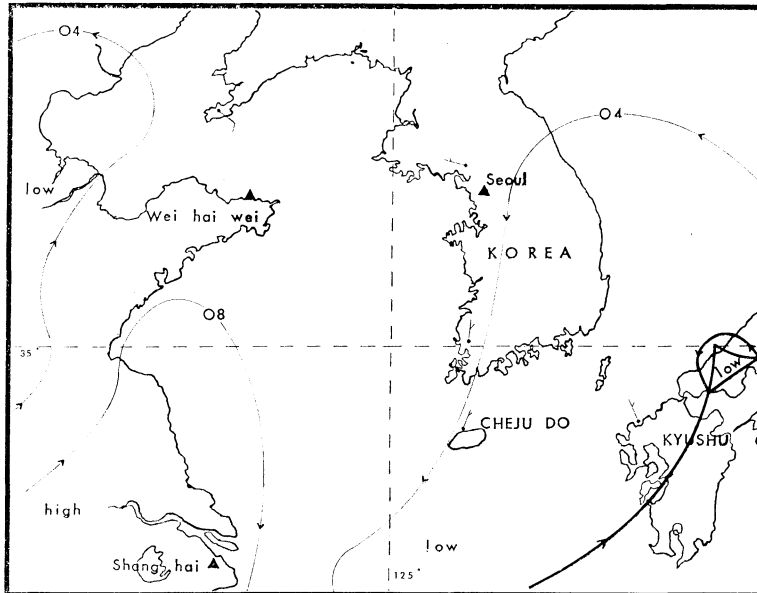

Map 8. The trajectory presented in this second series of maps, 7-10, indicates that the insects collected at 1400 on 15 May 1962, (Map 10) probably departed the Island of Cheju Do about 0200 (Map 8) on the same date. A low pressure system centered over Kyushu caused the winds to blow from the NNE.

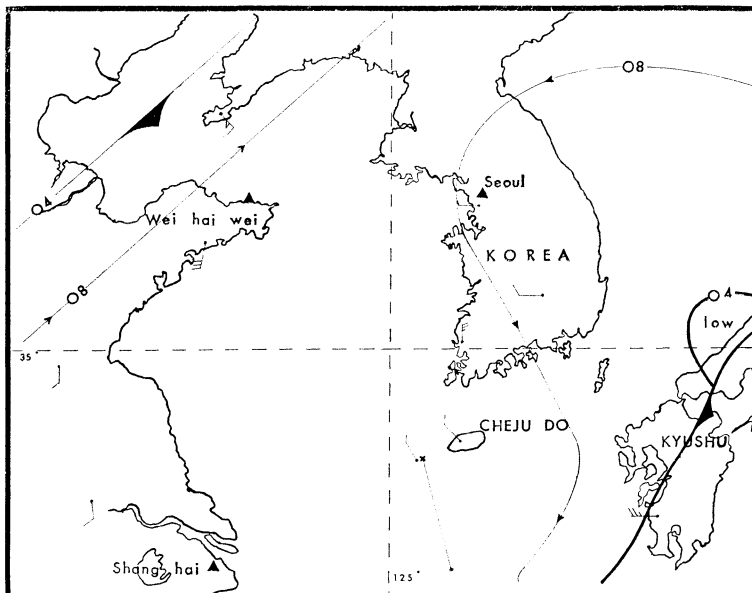

Map 9. By 0800 on 15 May the low pressure system had moved over Cheju Do which caused the winds to shift to the NW.

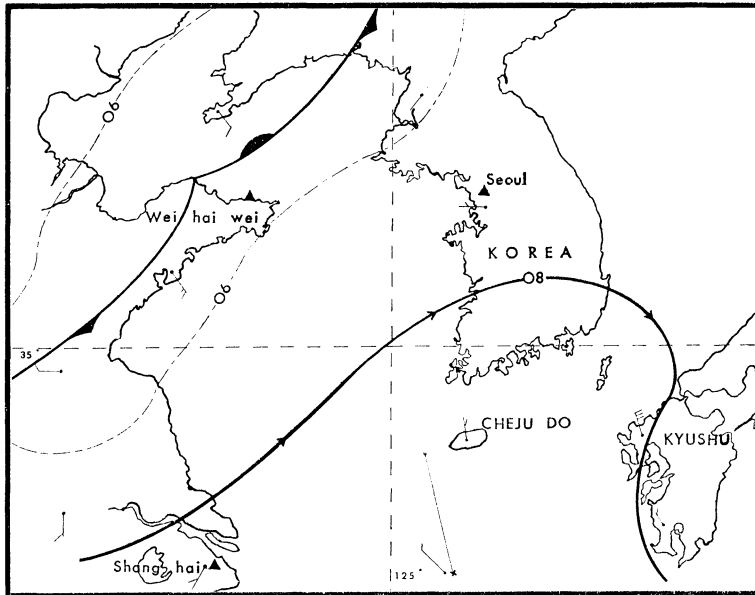

Map 10. If the assumption made in Map 8 is correct, the early morning winds carried the insects from Cheju Do to the SW, then shifted its course and moved the specimens to the SE until they were collected aboard ship at 1400.

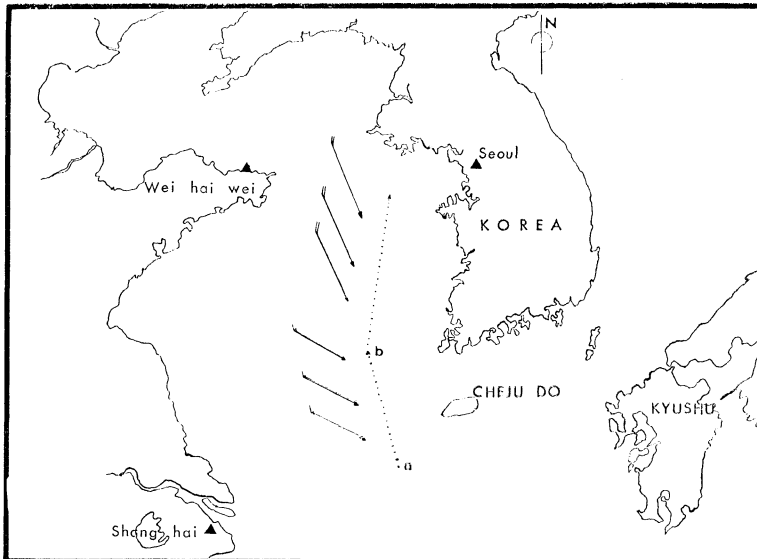

Map 11. Insect collecting was done along the course line shown by the dotted arrow shaft in Legs A and B, from south to north between 0700 on 6 October 1963 and 0600 on 7 October 1963. Wind arrows indicate that moderate breezes prevailed during both Legs, from the southwest on Leg A and from the northwest on Leg B. (See Maps 12-17.)

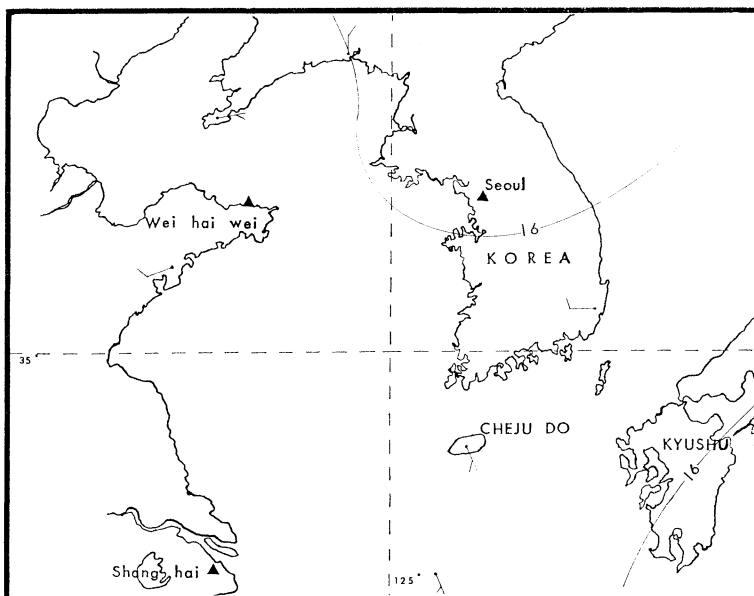

Map 12. A study of the weather preceding the recovery of specimens at 2000 on 6 Oct. 1963 leads one to postulate the probability that the insects departed Wei-wai-wei Peninsula at about 0200 on the same date. Map 12 presents area weather for 0200.

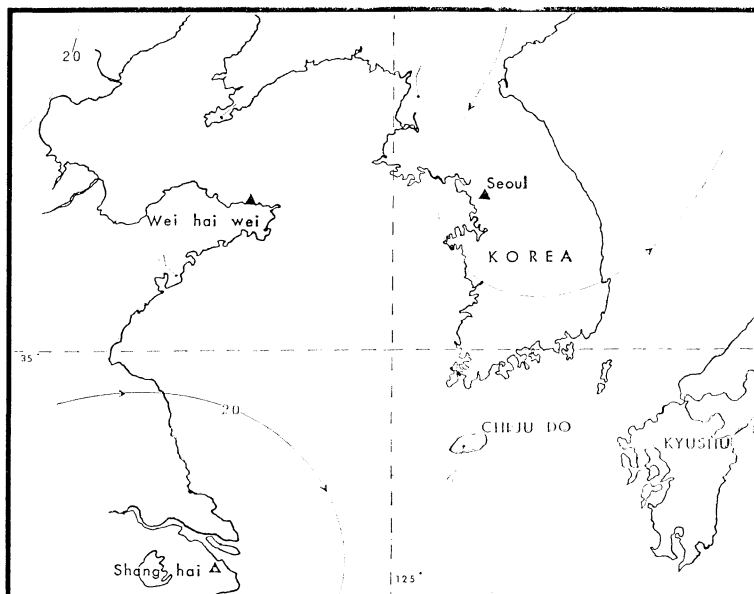

Map 13. The low pressure area shown in map 12 has moved E by 0800 and a high pressure system has appeared to the SSW. Insects borne by the prevailing winds would first move E and then S between the two systems.

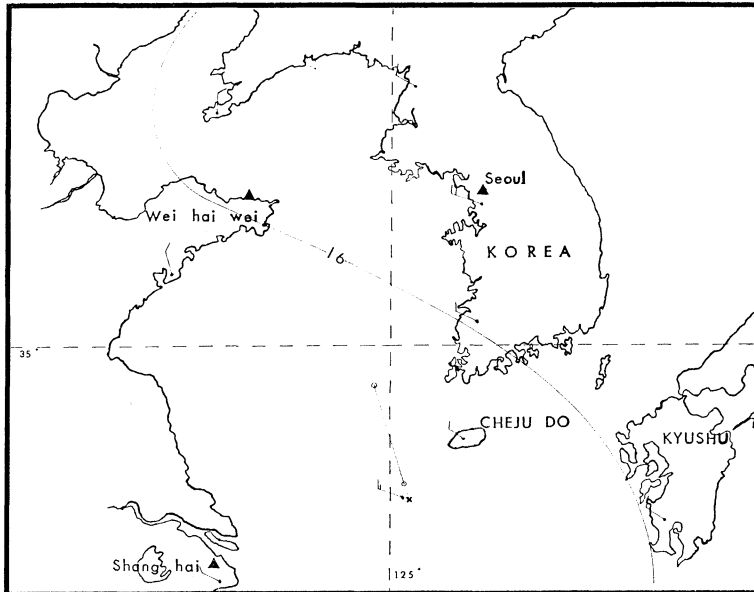

Map 14. By 1400 on the 6th the low pressure system had shifted to the W which caused the winds to blow from the NW.

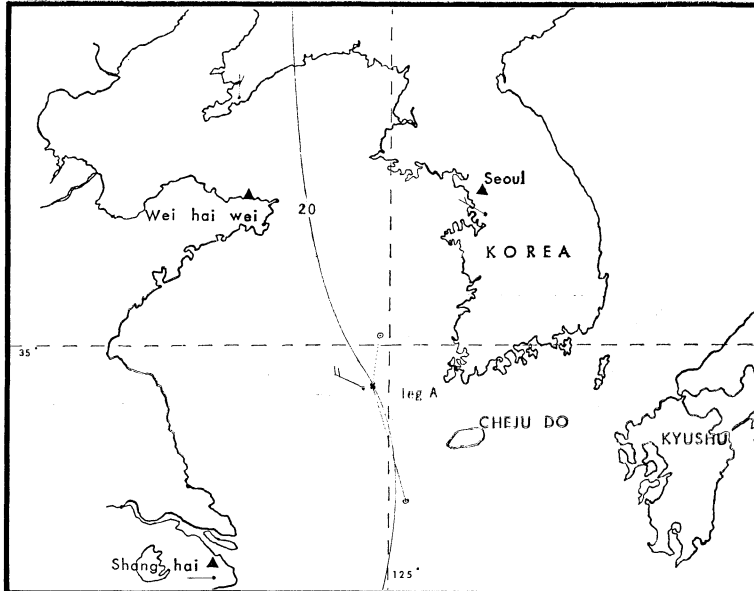

Map 15. The high pressure system (map 13) had moved rapidly to the E and at the time of the collection for Leg A (2000 hrs.) had intersected the ship's position.

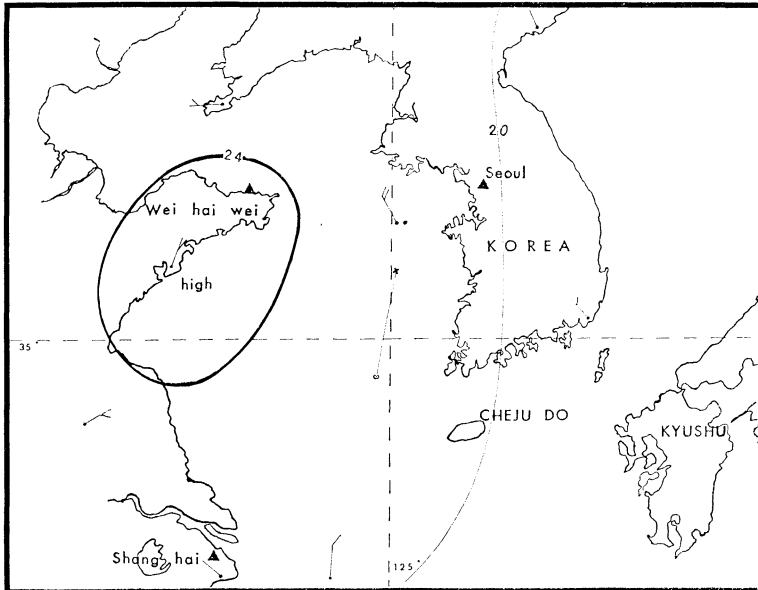

Map 16. The center of the high pressure system had moved to the E by 0200 hrs. on the 7th and one would suspect that all insects entering the collecting equipment to that hour had originated from the Wei-hai-wei Peninsula.

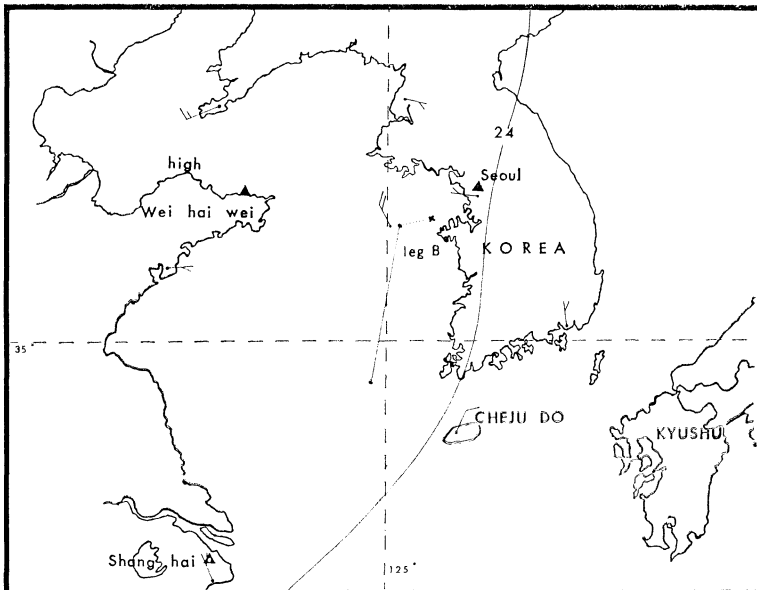

Map 17. When the collection from Leg was taken on the 7th at 0800, the high had expanded farther E and the winds were blowing from the NNW. The families represented in this collection tend to support the theory that during the night the insects collected came from the Wei-hai-wei Peninsula of China while those taken early in the morning came from the peninsula of Korea N of the ship.

between 1400 and 2000 on the 29th. This rise in temperature was probably caused by the passage of the frontal system over the area, and may have been enough to create a convective air current over the Peninsula area. Such a convective current could explain how the specimens got into the higher air flows. By 0200 on the 30th the low over the Yellow Sea had moved farther E towards Korea, and the S half of the frontal system had moved E towards Korea (Map 5). Wind was still blowing from the Wei-hai-wei area from the NW (325°), but had increased in velocity to 10 m/sec. (20 kn.). At 0800 on the 30th (Map 6), the frontal system that had developed in the low over the Yellow Sea and the ship's position intersected. The wind had increased to 13 m/sec. (25 kn.) over the Wei-hai-wei area, but still from the NW.

By tracing a path the specimens would take under the developing weather conditions, it would be possible to show that the specimens could have been carried aloft from the Wei-hai-wei area by a convective current, then moved SE with the frontal system across the Yellow Sea, towards Korea, until they were collected on the *Barrett* when the front and the ship's position intersected. The normal air turbulence created in weather fronts could explain how the specimens were dropped out of the upper air to be caught in the ship's trapping equipment just off the ocean's surface.

It is not likely that the specimens were blown from the Korean coastline, even though it was much closer than the China coast. The Korean coast was to the E of the ship's course, while the wind blew from the W for 48 hr preceding the collection on the 30th. This agrees with the development of a low pressure area in the Yellow Sea. Winds revolve counter-clockwise around low pressure areas in the northern hemisphere, and clockwise around high pressure areas. The low in the Yellow Sea was positioned so that when the winds developed by the low approached South Korea, they would be blowing from the W and SW, or from the ocean to the land.

The second set of specimens was collected at 1400, 15 May 1962, on another cruise of the *USNS Barrett* (Maps 7-10). At that time the wind was blowing from the NW (300°) at 5 m/sec. (10 kn.). Although the wind appeared to be blowing off the Chinese mainland, these specimens probably came from the island of Cheju Do.

At 0200 on the 15th, the wind was blowing NNE (030°) from Cheju Do and the tip of South Korea (Map 8). These winds blew almost parallel to a low pressure system centered over Kyushu which extended over central Korea. By 0800 on the 15th, (Map 9) part of this low pressure system had moved over Cheju Do eastwards towards Kyushu. The winds still blew from the N off the tip of Korea, but had increased their speed to 13m/sec. (25 kn.). Wind over Cheju Do had shifted to the NW (325°) at 5 m/sec. (10 kn.).

At 0800 on the 15th, the *Barrett* was only 55 km off the W coast of Cheju Do. The winds blowing off Cheju Do were still blowing from the NW at 1400 on the 15th (Map 10), when the specimens were collected.

If specimens had been picked up by the winds blowing off Cheju Do 12 hr earlier, 0200 on the 15th, and had followed the NE, then NW air flow at approximately 5 m/sec. (10 kn.), they would have been in an area approximately 215 km due S of Cheju Do. When the specimens were taken on the *Barrett* at 1400 on the 15th, the ship's position was approximately 215 km due S of Cheju Do.

The wind shift from a NE to NW direction would explain how the specimens would

appear to come from an area to the W of the collection point, because the winds were blowing from the NW when the specimens were collected.

When the 2256 specimens on Leg A (Map 11) of the *USNS Gaffey* were collected (6 October 1963), the wind was blowing at 9 m/sec. (18 kn.) from 302° (WNW). The nearest land to the NW was the Wei-hai-wei Peninsula, approximately 460 km away. It would take specimens 16 hr to travel that distance at 8 m/sec. (15 kn.). The specimens on Leg A were collected at approximately 2000 on the 6th, so the weather conditions at 0200 on the 6th start with Map 12. At that time the wind was blowing across the Wei-hai-wei Peninsula from the SW (240°) at 5 m/sec. (10 kn.) (Map 12). Winds moving in this direction would travel out across the Yellow Sea until they neared a low pressure system that had moved from Manchuria into the Yellow Sea. These winds would probably move in an E direction S of Seoul, Korea around this system. Six hours later (Map 13), this low pressure system had shifted 240 km E, still following its general pattern in Map 12. The winds over the Wei-hai-wei area then blew from the NW, following the flow of a high pressure system that developed N of Shanghai. Winds blowing between these 2 systems would move E at first, then blow S. Between 0800 and 1400 on the 6th (Map 14), the N half of the low pressure system shifted from North Korea westward to the Wei-hai-wei Peninsula. The high pressure system north of Shanghai moved westward into Central China. Winds now blew parallel to the low pressure system lying across the Wei-hai-wei area and the Yellow Sea SE towards the tip of South Korea (Map 14). Nine wind readings around the Yellow Sea area at this time verify this air flow. By 2000 on the 6th (Map 15), the pressure system had changed considerably. The low pressure system had moved E completely off the map, but the high pressure system shown in Map 13 had also moved E and occupied the area held 6 hr earlier by the low pressure system. Thus a NW air flow was still maintained. At 2000 on the 6th, this high pressure system and the ship's position intersected. By projecting a path from the Wei-hai-wei area, based on the different movements of the high and low pressure systems and the indicated wind speeds for the previous 18 hr, it can be shown that specimens could have been carried from this area to the ship's position at 2000 on the 6th.

As the ship moved N on Leg B (Map 11) of the cruise, the center of the high pressure area moved NE out of Central China to the Wei-hai-wei Peninsula (Map 16). At the same time the high pressure system shown on Map 15 extended E over Korea. Winds blowing parallel to this high pressure system blew from the NNW, while winds from the high over Wei-hai-wei continued to blow from the NE until they neared the Korean coast. Since collection equipment was in continuous operation between 2000 on the 6th and 0800 on the 7th, specimens entering the equipment during that period probably originated from the same area as those collected at the end of Leg A. The slight weather change shown between Maps 15 and 16 would tend to support this hypothesis. Leg B netted 695 specimens.

By 0800 on the 7th, the high over the Wei-hai-wei area had expanded E (Map 17) over Korea. Winds following this system blew from the NNW (340°). At the time of the collection at the end of Leg B, the ship's position was approximately 110 km due S of the peninsula extending into the Yellow Sea, NW of Seoul, Korea. At an average wind speed of 10 m/sec (20 kn.), it would take specimens a little over 3 hr to reach the ship's position from this peninsular area. Since winds had been blowing from the NNW for

nearly 6 hr previous, 0200 to 0800 on the 7th, it seems highly possible that some of the specimens taken at the end of Leg B came from this area. Thus it can be shown B that specimens taken in one 12 hr collecting period may have come from 2 widely separated areas. This could explain why out of the 31 families collected on Leg B of the cruise, 13 were not collected on Leg A, or of the 28 families collected on Leg A of the cruise, 7 were not collected on Leg B. It should also be noted that of 22 families caught on both Legs A and B, in almost every case more specimens of these families were collected on Leg A, even though Leg B ended much closer to land.

At present, to try and plot the movements of specimens over large areas by studying the weather conditions alone is impossible. For example, in Maps 7-10, by trying to locate the point of origin of specimens using only weather data from the collection point, a completely misleading point of origin may be assumed; or, as in map series 11-17, Leg B, it can be shown that specimens may originate from 2 entirely different areas in 1 sample. Multiply both of these cases by greater distances and less weather information and one begins to realize the magnitude of the problems involved.

While possible trajectories have been recorded for the specimens collected on these cruises, we are mindful of Hurst's (1965) statements concerning the uncertainties which arise in assessment of winds and height of flight any time a backtrack is presented. While there are always errors involved in such tracking, turbulence and other weather factors are most important on many occasions. The order of magnitude of error is such that after a 24-hr backtrack, a circle with a radius of approximately 110 km should include the actual source with only a 50% probability. For a 48-hr period, 150 km would be an appropriate radius.

Mindful of this possibility for error, it is felt that the results presented in this paper are relatively accurate since none of the specimens was collected over 550 km from land. While some attempts have been made to produce trajectories for species of limited distribution recovered much farther out at sea, none was conclusive enough to become a part of this article.

The most reliable way to measure and track the movement of an insect across an expanse of ocean would be to collect a specimen which could be identified as being endemic to a particular oceanic island. Armed with proof of origin, one could then plot weather conditions and relative winds from point of collection. Unfortunately, such ideal conditions are very seldom met and even when they are, the vertical factor further confuses the investigator.

DISCUSSION

From 1957 to 1967, Bishop Museum's program of trapping at sea has emphasized the movement of insects between land masses. This broad approach follows Schneider's (1962) views on dispersal as simply the movement from one place to another. Such movement may be mechanistically or teleologically motivated; the organism may be self-propelled, or it may be propelled by energy from some outside source. Wolfenbarger (1964) considered it to be an uncontrolled movement or a meandering about without a definite location as a goal. As the Museum's program evolves, attempts are being made to examine carefully each record to see if it was likely to be due to deliberate migration, to drift on

the wind, or to human interference. While Williams (1958) outline the need to include the consideration of the above points together with the records of observations of winged insects on ships far out at sea, any concentrated program of collecting aboard ships must consider the following possibilities :

1. The insects observed and/or collected may be routinely living aboard the ship.
2. While in port a ship may provide a haven from undesirable weather conditions or as desirable source of food, light at night, etc.
3. Food and cargo loaded aboard may harbor certain species.
4. The ship's movement away from, near or toward land may be an attracting force.
5. Farther at sea the ship may encounter insects which are migrating or immigrating—these may be attracted to the ship or the vessel may pass through their flyway.
6. Flying vertebrates may carry arthropods to the ship.
7. Weather conditions may be totally or partially responsible for the passive transport of wingless as well as winged insects, and spiders.

Previous to the frequent passage of ships and aircraft across oceans, weather was probably the primary mode by which the land masses of Oceania became populated; willful flight being the second most probable method. Williams (1949b) mentions a little understood phenomenon which may be important in the lateral transport of insects across oceans. If insects have attained considerable heights by flight and/or weather over land, they will tend to lose altitude as they move out to sea. As they approach the ocean's surface, they may be prevented from actually entering the water by a cushioning turbulence. This turbulent effect is relatively constant during normal weather but is destroyed by precipitation and other counter forces.

Overwhelming evidence in the literature as well as the Museum's ship trapping supports the theory that today man is the primary agent in transporting insects from one land area to another. Further research is required to determine accurately to what extent insects are distributed by nature across oceans.

Acknowledgments: The Entomology Department of Bishop Museum is indebted to the Office of Naval Research, the Pacific Science Board (Nat. Research Council), and the National Science Foundation (U. S. Antarctic Research Program) for financial support; to the U. S. Navy, the Military Sea Transportation Service, the U. S. Coast Guard, the U. S. Fish and Wildlife Service, Scripps Institution of Oceanography, Department of External Affairs, (Australia) Antarctic Division, Department of Scientific and Industrial Research (New Zealand), Antarctic Division and the Chilean Antarctic Program, for logistic support; the California Spray Chemical Corporation and the Tanglefoot Company for supplies; and to the U. S. Weather Bureau at Honolulu, the Federal Plant Quarantine at Honolulu, the Entomology Department of the Hawaii Agricultural Experiment Station and the Hawaiian Aeronautics Commission for technical assistance.

REFERENCES

- Andrewartha, H. G. 1961. Introduction to the study of animal populations. Univ. of Chicago Press, Chicago & London: 281 p.

- Barber, H. N., H. E. Dadswell, H. D. Ingle. 1959. Transport of driftwood from South America to Tasmania and Macquarie Island. *Nature* **184**: 203-04.
- Berland, L. 1934. Étude en avion de la faune entomologique aérienne. Académie des Sciences, Séance 18 Juin. p. 2201-03.
1935. Premiers résultats de mes recherches en avion sur la fauna et la flore atmosphériques. *Ann. Soc. Ent. Fr.* **104**: 73-96.
- Blumenstock, David I. 1959. The ocean of air. Rutgers University Press, New Brunswick, New Jersey: 457 p.
- Bonnet, A. 1911. Recherche sur le causes de variations de la faune entomologique aérienne. Academie des Sciences, Paris. **152**: 336-39.
- Carruthers, G. T. 1889. Locusts in the Red Sea. *Nature* **41**: 153.
- Clagg, H. B. 1966. Trapping of air-borne insects in the Atlantic-Antarctic area. *Pacif. Ins.* **8** (2): 455-66.
- Coad, B. R. 1931. Insects captured by airplane are found at surprising heights. *Yearbook of Agriculture* **1931**: 320-23.
- Collins, C. W. & W. L. Baker. 1934. Exploring the upper air for wind-borne gypsy moth larvae. *J. Econ. Ent.* **27**: 320-27.
- Dannreuther, Capt. T. 1933. Records of insect movement on land and at sea. *Entomologist* **66**: 17-19; **67**: 186-90.
- Darlington, P. J., Jr. 1938. The origin of the fauna of the Greater Antilles, with discussion of dispersal of animals over water and through the air. *Quart. Rev. Biol.* **13** (3): 274-300.
1957. Zoogeography: The geographical distribution of animals. John Wiley & Sons, Inc. New York. 8 vo. XI + 675 p.
- Dethier, V. G. 1945. The transport of insects in aircraft. *J. Econ. Ent.* **38**: 528-31.
- Dumbleton, L. J. 1950. Transport of insects on the exterior of aircraft. *Nature* **165** (4194): 452.
- Dunn, G. E. 1951. Tropical cyclones in compendium of meteorology. *Amer. Meteorol. Soc.* p. 887-901.
- Elton, C. S. 1925. The dispersal of insects to Spitsbergen. *Trans. Ent. Soc. Lond.* 1925: 289-99.
- Emerson, A. E. 1955. Geographical origins and dispersions of termite genera. *Fieldiana: Zoology* **37**: 465-521.
- Felt, E. P. 1925. Dispersal of butterflies and other insects. *Nature* **116**: 365-68.
1928. Dispersal of insects by air currents. *New York State Mus. Bull.* **274**: 59-131.
1938. Wind drift and dissemination of insects. *Canad. Ent.* **70** (11): 221-24.
- French, R. A. & J. H. White. 1960. The Diamond-back moth outbreak of 1958. *Plant Pathology* **9**: 77-84.
1961. Migration records. *Entomologist* **96**: 32-38 (Lep.).
- Gaines, J. C. & K. P. Ewing. 1938. The relation of wind currents as indicated by balloon drifts, to cotton flea hopper dispersal. *J. Econ. Ent.* **31**: 674-77.
- Gislén, Torsten. 1947. Aerial plankton and its conditions of life. *Biol. Rev. Cambridge Philos. Soc.* **23** (2): 109-27.
- Glick, P. A. 1939. The distribution of insects, spiders and mites in the air. *U. S. Dept. Agric., Tech. Bull.* **673**.
1957. Collecting insects by airplane in Southern Texas. *U. S. Dept. of Agric. Tech. Bull.* **1158**: 1-28.
1965. Review of collections of Lepidoptera by airplane. *J. Lepidopt. Soc.* **19** (3): 129-37.
- Greenbank, D. O. 1957. The role of climate and dispersal in the initiation of outbreaks of the spruce budworm in New Brunswick. *Canad. Ent.* **35**: 385-404.
- Gressitt, J. L. 1960. The development of insect faunae in Oceania. Darwin-Wallace Centenary (Centenary and Bicentenary Congress), Univ. of Malaya, Singapore, p. 58-62.
1961. Zoogeography of Pacific and Antarctic insects. *Pacif. Ins. Mongr.* **2**: 1-94.

- Gressitt, J. L., J. L. Coatsworth, C. M. Yoshimoto. 1962. Air-borne insects trapped on "Monsoon Expedition." *Pacif. Ins.* 4 (2): 319-23.
- Gressitt, J. L., R. E. Leech, T. S. Leech, J. Sedlacek, K. A. J. Wise. 1961. Trapping of air-borne insects in the Antarctic area (Part 2). *Pacif. Ins.* 3 (4): 559-62.
- Gressitt, J. L., R. E. Leech, C. W. O'Brien. 1960. Trapping of air-borne insects in the Antarctic area. *Pacif. Ins.* 2 (2): 245-50.
- Gressitt, J. L. & S. Nakata. 1958. Trapping of air-borne insects on ships on the Pacific. *Proc. Hawaii. Ent. Soc.* 16 (3): 363-65.
- Gressitt, J. L., J. Sedlacek, K. A. J. Wise, C. M. Yoshimoto. 1961. A high speed airplane trap for air-borne organisms. *Pacif. Ins.* 3 (4): 549-55.
- Gressitt, J. L. & C. M. Yoshimoto. 1963. Dispersal of animals in the Pacific. In Gressitt, Pacific Basin Biogeography, *Tenth Pacif. Sci. Congr.* p. 283-92.
- Gressitt, J. L., et al. 1964. Insects of Campbell Island. *Pacif. Ins. Monogr.* 7: 1-663.
- Guppy, H. B. 1925. Dispersal of butterflies and other insects. *Nature* 116: 543.
- Hardy, A. C. & P. S. Milne. 1937. Insect drift over the North Sea. *Nature* 139: 510-11.
1938. Studies in the distribution of insects by aerial currents. *J. Anim. Ecol.* 7: 199-229.
1938. Aerial drift of insects. *Nature* 141: 602-03.
- Harrell, J. C. & E. Holzapfel. 1966. Trapping of air-borne insects on ships in the Pacific, Part 6. *Pacif. Ins.* 8 (1): 33-42.
- Harrell, J. C. & C. M. Yoshimoto. 1964. Trapping of air-borne insects on ships on the Pacific, Part 5. *Pacif. Ins.* 6 (2): 274-82.
- Heape, Walter. 1931. Emigration, migration and nomadism. Cambridge. p. 369.
- Henson, W. R. 1951. Mass flights of the spruce budworm. *Canad. Ent.* 83: 240.
1960. Convective transportation of *Choristoneura fumiferana* (Clem.). *XI Intern. Kongr. Ent.* Wien 3: 44-46.
- Herring, J. L. 1958. Evidence for hurricane transport and dispersal of aquatic Hemiptera. *Pan-Pacif. Ent.* 34 (3): 174-75.
- Hingston, R. W. G. 1925. Animal Life at high altitude. *Geogr. J.* 65: 186-98.
- Hocking, B. 1953. The intrinsic range and speed of flight of insects. *Trans. Ent. Soc. Lond.* 104: 223-345.
- Holzapfel, E. P. & J. L. Gressitt. 1964. Airplane trapping of organisms and particles. *Proc. Atmospheric Biol. Conf.* Minn. p. 151-63.
- Hurst, G. W. 1965. *Laphygrua exigua* immigrations into the British Isles, 1947-1963. *Int. J. Biometeor.* 9 (1): 21-28.
- Johnson, C. G. 1955. Ecological aspects of aphid flight and dispersal. *Rep. Rothamst. Exp. Sta.* 1955: 191-201.
1957. The distribution of insects in the air and the empirical relation of density to height. *J. Anim. Ecol.* 26: 479-94.
1960. A functional approach to insect migration and dispersal and its bearing on future study. *XI Intern. Kongr. Ent.*, Wien 3: 50-53.
1960. The present position in the study of insect dispersal and migration. *Rep. Seventh Commonwealth Ent. Conf.* 1960: 140-45.
1963. The aerial migration of insects. *Scient. Amer.* 209 (6): 132-38.
- Laird, Marshall. 1951. Insects collected from aircraft arriving in New Zealand from abroad. *Zool. Pub. Victoria Univ. Collegel*: 1-30.
1952. Insects collected from aircraft arriving in New Zealand during 1951. *J. Aviation Med.* 23: 28-285.
- Mani, M. S. 1962. Introduction to high altitude entomology. Methuen & Co., Ltd., London: 302 p.
- McClure, H. E. 1938. Insect aerial populations. *Ann. Ent. Soc. Amer.* 31: 504-13.
- Medler, J. T. 1960. Long range displacement of Homoptera in the Central United States. *XI Intern. Kongr. Ent.* Wien 1960: 30-35.

- Meier, C. 1935. Collecting micro-organisms from the Arctic atmosphere. *Scient. Mon.*, N. Y. **40**: 5.
- Odintsov, V. C. 1960. (Air-catch of insects as a method of studying the entomofauna of vast territories). *Ent. Obozrenie* **39** (1): 227-30.
- Pemberton, C. E. 1944. Insects carried in transpacific airplanes. *Hawaii. Plant. Rec.* **48** (3): 183-86.
- Pienkowski, R. L. & J. T. Medler. 1963. Air masses associated with long range movement of the potato leafhopper into Wisconsin. *Proc. XVI Intern. Congr. Zool. Wash.*, D. C.
1964. Synoptic weather conditions associated with long-range movement of the potato leafhopper, *Empoasca favae*, into Wisconsin. *Ann. Ent. Soc. Amer.* **57** (5): 588-91.
- Poulton, E. B. 1921. Mimicry in the butterflies of Fiji. *Proc. Roy. Ent. Soc. Lond.* 1921: 564-675.
1923. Notes on the migration of Lepidoptera, with a suggestion as to the cause of the backward and forward flight occasionally observed. *Trans. Ent. Soc. Lond.* 1923: 12-16.
1931. Immense numbers of a large mantid and moths blown on to a ship off the E. coast of Africa. *Proc. Roy. Ent. Soc. Lond.* **5** (3): 84.
- Schneider, F. 1962. Dispersal and migration. *Ann. Rev. Ent.* **7**: 223-42.
- Schuchert, C. 1935. Historical geology of the Antillean-Caribbean region. Wiley & Sons, 79-110.
- Taylor, L. R. 1962. The absolute efficiency of insect suction traps. *Ann. Appl. Biol.* **50**: 405-21.
- Thornton, I. B. W. 1964. Air-borne Psocoptera trapped on ships and aircraft. *Pacif. Ins.* **6** (2): 285-91.
- Thornton, I. B. W. & J. C. Harrell. 1965. Air-borne Psocoptera trapped on ships and aircraft, 2—Pacific ship trapping, 1963-64. *Pacif. Ins.* **7** (4): 700-02.
- Walker, J. J. 1931. Insects at sea. *Ent. Mon. Mag.* **67**: 211-32; 254-68.
- Wellington, W. G. 1945a. Conditions governing the distribution of insects in the free atmosphere, I. *Canad. Ent.* **77** (1): 7-15.
- 1945b. Conditions governing the distribution of insects in the free atmosphere, II. *Canad. Ent.* **77** (2): 21-28.
- 1945c. Conditions governing the distribution of insects in the free atmosphere, III. *Canad. Ent.* **77** (3): 44-49.
- Wheeler, W. M. 1916. Ants carried on a floating log from the Brazilian coast to San Sebastian Island. *Psyche* **28**: 180.
- White, R. A. Senior. 1949. Transport of insects on the exterior of an aircraft. *Nature* **164** (4158): 60-61.
- Whitfield, F. G. S. 1939. Air transport, insects and diseases. *Bull. Ent. Res.* **30**: 365-442.
- Williams, C. B. 1930. The migration of butterflies. Oliver and Boyd. Lond: 473 p.
1943. The migration of butterflies. *Proc. Linn. Soc. Lond.* 1941-42. p. 86-87.
- 1949b. Insect flight and distribution. *Nature* **164**: 904-05.
1958. Insect migration. London: Collins 235 p.
- Williams, C. B., et al. 1942. Studies in the migration of Lepidoptera. *Trans. Ent. Soc. Lond.* **92**: 101-280.
- Wollaston, A. F. R. 1922. The natural history of South Western Tibet. *Geogr. J.* **60** (1): 5-20.
- Yoshimoto, C. M. & J. L. Gressitt. 1959. Trapping of air-borne insects on ships on the Pacific (Part II). *Proc. Hawaii. Ent. Soc.* **17** (1): 150-55.
1960. Trapping of air-borne insects on ships on the Pacific (Part III). *Pacif. Ins.* **2** (2): 239-43.
1961. Trapping of air-borne insects on ships on the Pacific (Part IV). *Pacif. Ins.* **3** (4): 556-58.
1963. Trapping of air-borne insects in the Pacific-Antarctic area, 2. *Pacif. Ins.* **5**(4): 873-83.
- Yoshimoto, C. M., J. L. Gressitt, C. J. Mitchell. 1962. Trapping of air-borne insects in the Pacific Antarctic area I. *Pacif. Ins.* **4** (4): 847-58.
- Yoshimoto, C. M., J. L. Gressitt, T. Wolff. 1962. Air-borne insects from the Galathea Expedition. *Pacif. Ins.* **4** (2): 269-91.
- Zimmerman, E. C. 1948. Insects of Hawaii, vol. 1, Introduction. Univ. Hawaii Press, Honolulu.